

2025 Fully-Priced Buying Guide

Boat Show Edition

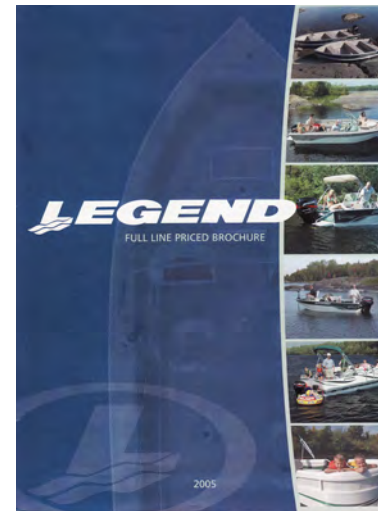

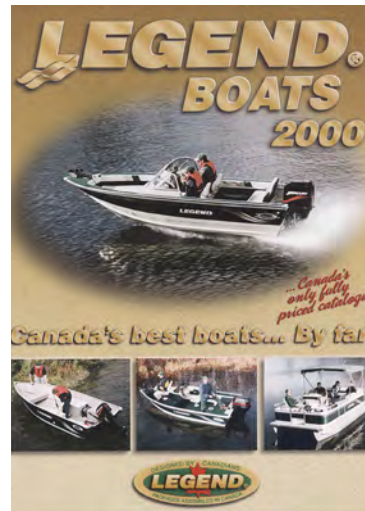
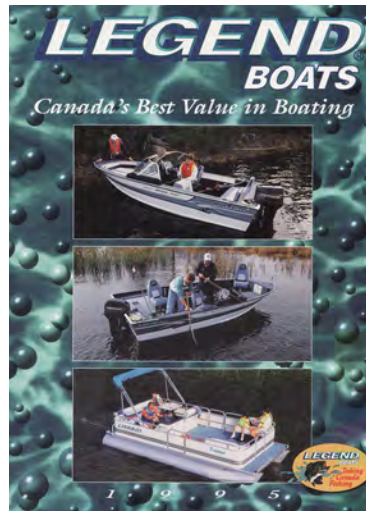

## Are You All-In? CANADA'S ONLY FULLY-PRICED CATALOGUE, SINCE '87.



In a world where we are bombarded with fees, surcharges and extras, wouldn't it be nice if a company would just tell us what it's going to cost up front? Legend Boats is that company. Our prices are All-In!

That's right! No administration fees. No hidden freight fees. No rigging fees. Since 1987, our customers have enjoyed having full package pricing at their fingertips so

they could figure out what their perfect boat or pontoon boat was going to cost right down to the penny. Now, there's no more figuring out. With one simple up-front price, you choose your motor and any options you want, then simply add the taxes. We would have gotten rid of those too but we thought it may have been frowned upon. It really couldn't get any more simple, open, honest or transparent, and we feel that you will appreciate our All-In Pricing.

\*We only print one version of our catalogue for all of Canada. Customers outside of Ontario and Quebec will have a small fee for freight. Prices are listed as of: 01/01/2025, prices are subject to change without notice. For details, visit us at [legendboats.com](http://legendboats.com) for your local, ALL-IN, No-Fee Price including current promotions.

# We do things a little differently.

## Is Legend Canadian?

Yes. We are a Canadian company. We live and play where you do. We understand boating in the unique Canadian wilderness. It's different here, and that's why each and every model is designed by Canadians and built for Canadians. From thicker aluminum to full stand-up tops, we make sure that Mother Nature is no match for your Legend.

## Are Legend boats built in Canada?

Yes and No. Our product developers seek out quality manufacturers throughout North America who can produce in the most cost effective way. By outsourcing component manufacturing and then performing all final assembly, sales, service, and warranty right here in Canada, we ensure that the end product is fit for the Great Canadian outdoors.

## Are the printed catalogue prices MSRP?

No. The printed price is our hassle-free, lowest price. We provide it up front, so there's no need for uncomfortable negotiations. To top it off, aside from a small variance in freight, our low prices are the same across Canada. Now you can make an informed, easy, and no-pressure decision in the comfort of your own home.

## It seems like everyone's warranty is pretty much the same. Is that the case?

Well, at first glance it appears that most companies are offering some sort of lifetime warranty, and it's easy to assume that all warranties are the same, but the devil is in the details. By details, we're talking about the fine print. Our 6 year WOWranty combined with our Lifetime hull warranties give you the absolute best warranty coverage, bar none. Not only do we cover more stuff for longer, but the best part is that everything is taken care of right here in Canada.

## Someone told me Legend boats are underpowered. Is that true?

No. You can actually power your boat with the engine of your choice. Each Legend boat model is designed and packaged with a Mercury motor large enough to get you and a friend on the water to experience the boating lifestyle with minimal investment. We understand that everyone's boating needs are different, and that the packaged motor may not suit your needs. That's why we make it easy to choose the perfect Mercury outboard to power all of your on-water activities. So, whether you want to troll all day, bring the kids tubing, cruise with your family or pull two water skiers, we'll help you select the engine that's just right.

## Why do you only package your boats with Mercury outboards?

We partner exclusively with Mercury because of their proven quality, value, reliability, service and features. With the large number of clients we help onto the water each year in Canada, other outboard manufacturers would love us to package with their brand. Mercury appreciates our business so much, they offer us exclusive savings that we simply pass on to you. That's how we package with the oldest, largest, number one outboard engine brand at such an incredible price. On top of a great price, by purchasing a complete custom package you'll enjoy consistent performance and one-location servicing.

## We give you the most standard equipment.

We've outfitted our boats with more equipment for less. Things that you would have to pay thousands of dollars extra for with other brands are simply part of our value-packed models. Many of our Legend packages have standard features like Dura-deck vinyl floors, automatic bilge pumps, and a bunch of other great stuff that is optional in other brands. When it comes to value, we're proud to say that nobody compares. We have more equipment for less than any other brand!

## You claim your quality is good but your prices are affordable. How is that possible?

You get what you pay for right? Well in most cases, yes. But at Legend, we never sacrifice quality in order to reduce cost. Our use of quality brand name products in our packages such as Shoreland'r trailers, Minn Kota and Garmin trolling motors and Mercury outboards - the largest brands in boating - speak for themselves. To keep prices low, we build fewer models in higher volumes and package each model with the same popular features. By purchasing thousands of each component, such as full stand-up tops, fish finders and GPS', we can offer you unbelievably high quality at affordable prices. That's how we do it.

## Why doesn't everyone put pricing in their catalogues?

That's a great question. We don't know. It could be because it takes a lot more work and effort to include all of the details required when you're sharing a price. Or, perhaps nobody else does it because they have something to hide. But we're only guessing. All we know is that we're so confident that we offer the absolute best value in Canada that we publish our complete, hassle-free, all-In pricing for all to see. You can find our prices in our full line brochure, on our extensive website and in all of our advertisements. We even print the pricing of our most popular options so you can "build" your own Legend. Nothing is hidden and it's all in Canadian dollars. We've done the work for you and given you our lowest price right up front.



## 2025 XT Quick Guide

Available in 17', 18', 19' and 20'

With our versatile design, you can seamlessly transition from a relaxing day on the water with your loved ones to an exciting fishing adventure. The XT combines durability, comfort, and functionality, ensuring that every outing is enjoyable for the whole family. Choose between one of our 4 XT sizes for your best fit. For even more thrills on the water, add the Sport Package for enhanced versatility, comfort, and family-friendly features.



Chilli Pepper Red and stealth grey diamond embossed furniture.



Sapphire Blue and cognac diamond embossed furniture.



## XT Surprisingly Included Equipment



### PREFERRED EQUIPMENT PACKAGE

Full Stand-Up Top with Forward Facing Sport Top Bimini	\$2,399
In-Dash Humminbird Helix 7 GPS Fish/Depth Finder	\$1,349
Bow Contoured Backrests	\$849
Bluetooth AM/FM Stereo with MP3 Port and 2 Speakers	\$799
Interior LED Ambient Lighting	\$699
Tilt Steering	\$599
Space-Saving Trailer Swing Tongue	\$499
Swim Platform with Fold Down Step(s)	\$399
<i>Plus, on the 20XT only:</i> 1 Ergomax Reclining Captains Chair	\$1,599

---

**Value: \$9,191\***

The total value includes all items, including the exclusive captain's chair unique to the 20XT. For the 17, 18, and 19 items, the total is: \$7,592.



## Dual purpose innovation.

The All-New 'Frunk' (Front Trunk) Whether it's wide open for easy walk-in bow access or securely closed to stash your gear, the Frunk gives you the extra space you need to make every trip effortless. It's storage, your way.





## Everything in its place, and then some.

The XT makes it easy to stay organized and ready for anything. An aerated stern livewell keeps your catch fresh, while the rear casting deck with storage compartments ensures your gear is always within reach. Add in the in-floor rod locker, our innovative Frunk and spacious bow storage, and you've got room for everything—and then some.

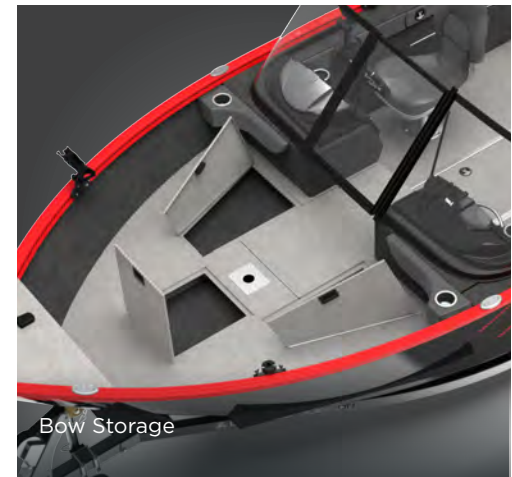
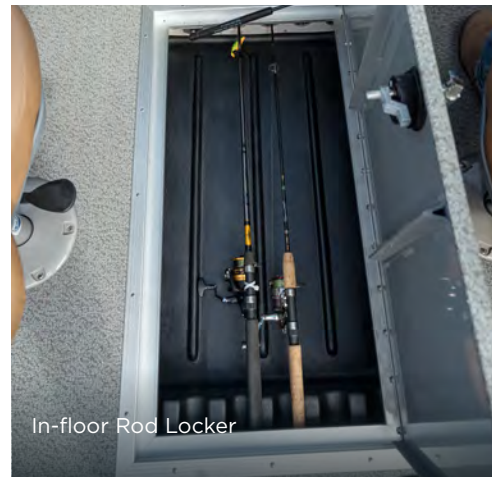
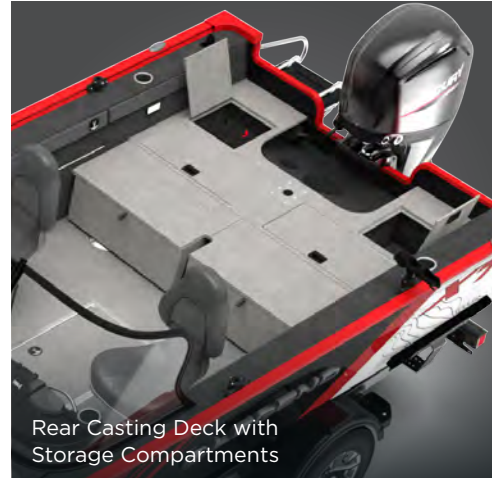

# Railmountz Integrated Gunnel System (RIGS) **Versatile. Secure. Unlimited Possibilities.**

Whether you're an angling ace or a watersports warrior, our track system adapts effortlessly to your needs. With unparalleled versatility and ease of use, you can securely attach and adjust Railmountz accessories on-the-fly, ensuring your every adventure is optimized for your needs—it's your vessel, your way.

A pair of rod holders are included for convenience. Other Railmountz accessories can be added. Be sure to check them all out!

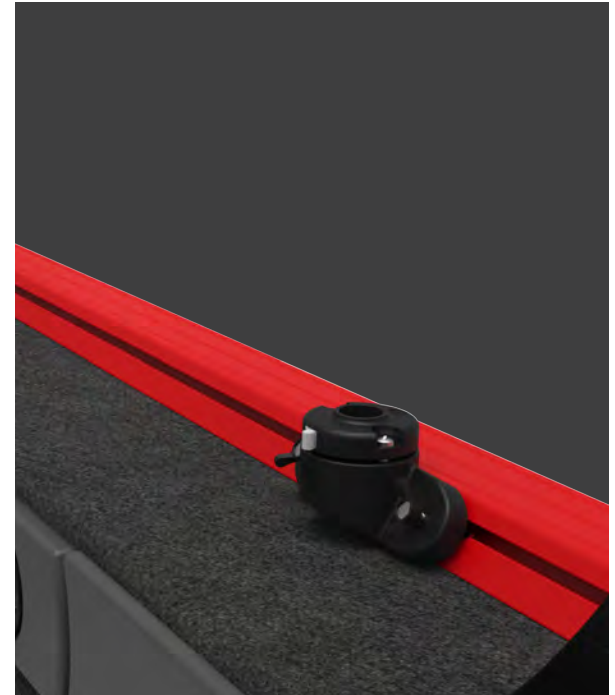





## The Full Stand-Up Top with a forward-facing sport bimini

combines modern style with ultimate protection, keeping you comfortable, warm, and dry in any weather. Designed for versatility and performance, it's your perfect companion for every on-water adventure, no matter what Mother Nature has in store. The all-new forward-facing sport bimini seamlessly integrates with the Railmountz Integrated Gunnel System, making it even easier to adjust or remove at any time.



## Escape to the water

Enjoy the added luxury of the ErgoMax Reclining Captain's Chair, designed for ultimate support and relaxation on the 20XT. From the versatile 4-on-the-floor seating to the plush bow deck backrest, every detail is crafted for comfort. Bow bolsters and cushions provide the perfect spot to unwind, while the luxury diamond-patterned upholstery adds a touch of elegance to every adventure.

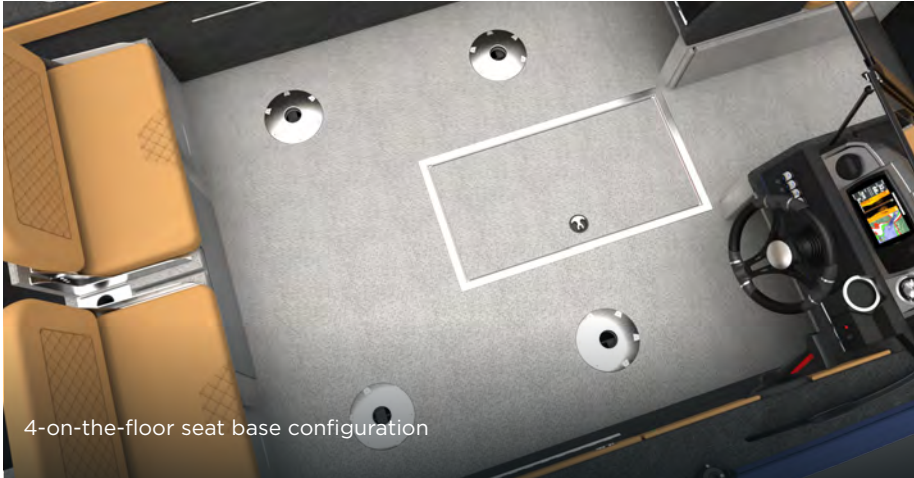

4-on-the-floor seat base configuration



ErgoMax Diamond Reclining Captain's Chair\*

\*Exclusive to 20XT



Bow bolsters and cushions\*

\*Cushions only on sport package



Plush 50/50 split seat backrest with sleek diamond-pattern stitching



**Ready to cast,  
ready to relax.**

**The EZ-Flip 50/50 Split Extenda-Deck  
Converta-Bench and Swim Platform**

Transform your casting deck into a dual-seat bench in seconds—perfect for fishing, cruising, or relaxing by the water. Paired with the rear swim platform, it's the ultimate setup for fun and adventure. So simple, even the kids can do it!

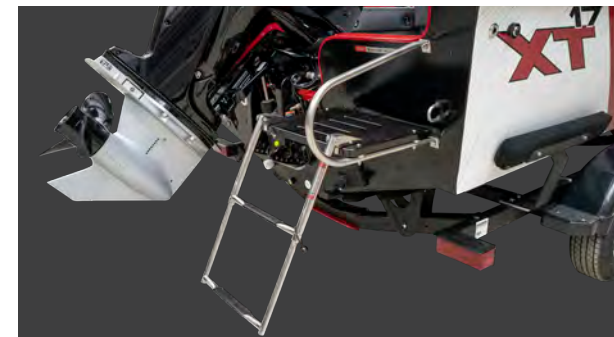



Equipped with the  
HELIX 7 CHIRP MEGA SI GPS G4N



## Discover the water like never before.

Features MEGA Side Imaging, MEGA Down Imaging, Dual Spectrum CHIRP Sonar, AutoChart Live, Internal GPS and Humminbird Basemap built-in. An upgraded high-definition 7" display will give you the best view of the many pre-loaded split screen view options so that you'll never miss a fish.



Premium Jensen receiver for crystal-clear audio and seamless connectivity. Bluetooth, USB, and AUX connectivity,



Backlit Tachometer and Fuel Gauges



Illuminated Switches



Deluxe passenger console with lockable Integrated Storage + Cool Box, cup holder and small tray



Cool Box to fit refreshments and ice packs

## The Sports Package

Add the Sports Package \$2,499 to any XT model to create the ultimate Family Fish and ski boat. The XT Sports Package includes a full Convertible Bow Cushion Set, a Bow Deck Backrest, a Removable Solid Brushed Aluminum Ski Pylon, Colour-matched Sport Trailer graphics and Night View Safety Mirrors with Integrated Docking and Boarding Lights.



**Sport Package Trailer**  
with colour-matched graphics



### **Removable Solid Brushed Aluminum Ski Pylon: Built for Big Air and Smooth Rides.**

Strong, reliable, and built for adventure—the XT’s Ski Pylon is your ultimate watersports partner, ready to tackle every thrill with ease.



### **NightView Safety Mirrors with integrated lights: Keep an eye on the action**

Durable, adjustable, and always on duty—Railmountz Safety Mirrors keep you connected to the action, while integrated docking and boarding lights ensure visibility and ease, even after the sun sets.



### **Bow Cushions: Turn a Great Seat Into the Best Spot on the Water.**

Enhancing the XT’s bow lounge, these bow cushions pair perfectly with the included bolsters to create a cozy, wrap-around seating experience, making the front of the boat everyone’s favorite hangout.



### **Bow Lounging Done Right: Where Comfort and Adventure Meet.**

The XT’s Bow Deck Backrest creates the perfect front-row seat to your next adventure. From sunbathing to extra seating for guests, it’s a space designed to make every moment on the water feel just right.

**ALL-IN PRICE**  
NO EXTRA FEES\*

# XT-SERIES

WE'VE GOT YOU COVERED

- .100 Gauge**  
Perfect-Flex Aluminum
- All-Welded**  
Aluminum Hull
- Leakproof + 6 Year**  
For Life Warranty
- 5YR**  
WOWranty



## SPECIFICATIONS

	17XT	18XT	19XT	20XT
Length	16'7"	17'6"	18'6"	19'6"
Beam	90"	90"	94"	97"
Hull Depth	41"	41"	42"	45"
Inside Depth	26"	26"	28"	31"
Bottom Width	76"	76"	76"	76"
Aluminum Thickness	0.100	0.100	0.100	0.100
Maximum Horsepower	115	150	150	175

	17XT	18XT	19XT	20XT
Maximum Capacity(lbs)	1631	1744	1744	1949
Hull Weight (lbs)	1345	1396	1435	1530
Towing Weight (lbs)	2566	2654	2937	2996
Package Length	19'9"	19'9"	20'9"	21'1"
Package Width	92"	92"	96"	100"
Gas Tank	95L (25US gal)	95L (25US gal)	132L (35US gal)	132L (35US gal)





## KEY STANDARD FEATURES

- EZ-Flip 50/50 Extenda-Deck Converta-Bench
- 2 ErgoMax 360° Swivel Chairs
- Convertible Bow with Frunk
- Deluxe Command-Vu Console
- Port and Starboard battery storage area
- 75 Litre (20 US gallons) aerated stern livewell
- RIGS - Railmountz Integrated Gunnel System
- Flow-through storage vents

### 17 XT

**\$116** Per Week | **\$55,999\***

With Mercury 90 ELPT 4S and Glide-On Trailer



Build me!

#### Choose Your Power

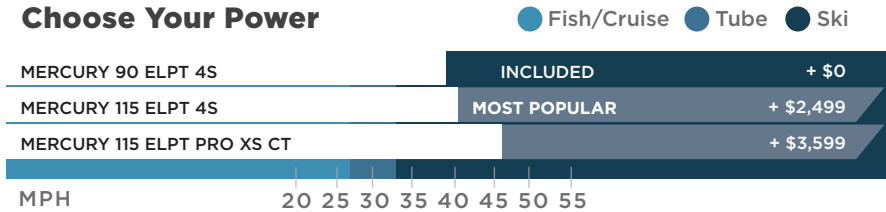

### 18 XT

**\$120** Per Week | **\$57,999\***

With Mercury 90 ELPT 4S and Glide-On Trailer



Build me!

#### Choose Your Power

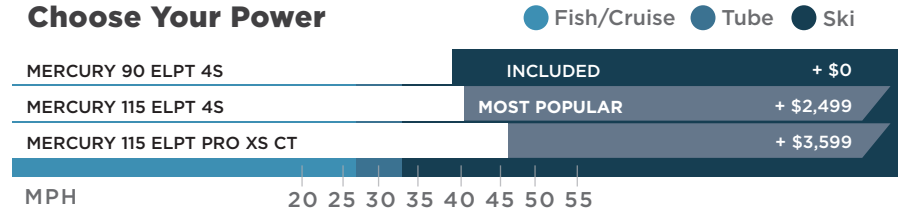

### 19 XT

**\$141** Per Week | **\$67,999\***

With Mercury 115 EXLPT 4S and Glide-On Trailer



Build me!

#### Choose Your Power

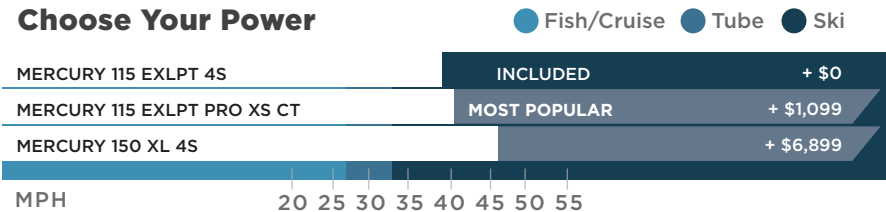

### 20 XT

**\$149** Per Week | **\$71,999\***

With Mercury 115 EXLPT 4S and Glide-On Trailer



Build me!

#### Choose Your Power

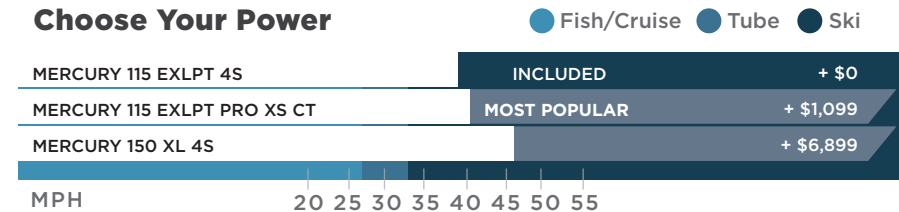



## 17 XT

### Specifications

Length 16'7"  
Beam 90"

Towing Weight 2566lbs  
Hull Weight 1345lbs  
Max HP 115

### Key Standard Features

EZ-Flip 50/50 Extenda-Deck Converta-Bench  
2 ErgoMax 360° Swivel Chairs  
Convertible Bow with Frunk  
Deluxe Command-Vu Console  
Passenger Console with Integrated Cool Box  
Port and Starboard battery storage area  
75 Litre (20 US gallons) aerated stern livewell  
RIGS - Railmountz Integrated Gunnel System  
Flow-through storage vents



## 18 XT

### Specifications

Length 17'6"  
Beam 90"

Towing Weight 2654lbs  
Hull Weight 1396lbs  
Max HP 150

### Key Standard Features

EZ-Flip 50/50 Extenda-Deck Converta-Bench  
2 ErgoMax 360° Swivel Chairs  
Convertible Bow with Frunk  
Deluxe Command-Vu Console  
Passenger Console with Integrated Cool Box  
Port and Starboard battery storage area  
75 Litre (20 US gallons) aerated stern livewell  
RIGS - Railmountz Integrated Gunnel System  
Flow-through storage vents



## 19 XT

### Specifications

Length 18'6"  
Beam 94"

Towing Weight 2937lbs  
Hull Weight 1435lbs  
Max HP 150

### Key Standard Features

EZ-Flip 50/50 Extenda-Deck Converta-Bench  
2 ErgoMax 360° Swivel Chairs  
Convertible Bow with Frunk  
Deluxe Command-Vu Console  
Passenger Console with Integrated Cool Box  
Port and Starboard battery storage area  
75 Litre (20 US gallons) aerated stern livewell  
RIGS - Railmountz Integrated Gunnel System  
Flow-through storage vents



## 20 XT

### Specifications

Length 19'6"  
Beam 97"

Towing Weight 2980lbs  
Hull Weight 1604/1530lbs  
Max HP 175

### Key Standard Features

EZ-Flip 50/50 Extenda-Deck Converta-Bench  
2 ErgoMax 360° Swivel Chairs  
Convertible Bow with Frunk  
Deluxe Command-Vu Console  
Passenger Console with Integrated Cool Box  
Port and Starboard battery storage area  
75 Litre (20 US gallons) aerated stern livewell  
RIGS - Railmountz Integrated Gunnel System  
Flow-through storage vents  
1 ErgoMax 360° Captain's Chair

## Built to Last. Leakproof for Life. Guaranteed.

### Super-Thick .100 Gauge One-Piece Seamless Hull

With this seamless hull, your Legend boat will last longer with no potential for centre-seam leaks. While our .100 Gauge hulls provide unmatched thickness, our use of Legend's H34 PerfectFlex aluminum provides the best combination of flexibility and strength.

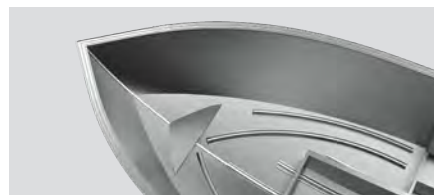
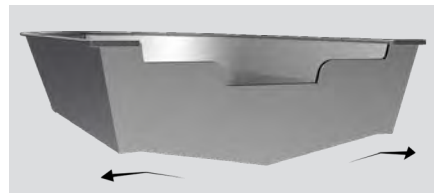
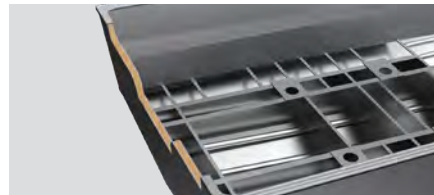
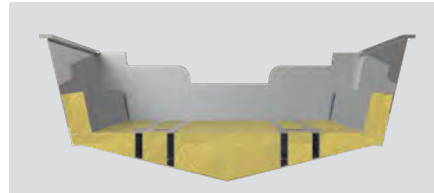
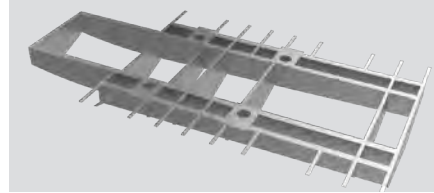

### Torsion Beam Energy Transfer + Intelliflex Hull

Provides your boat with necessary flexing, while remaining light and strong. Thanks to the built-in torsion beam energy system, the XT's hull flexes, adapts, and dissipates wave energy evenly throughout the hull, preventing problem areas from forming over time.

### Quiet Core Injected Foam

Our inject closed cell foam helps with sound deadening and buoyancy, adding to the overall luxury and performance of our boats. Not only will every Legend float even when filled with water, the injected foam creates a solid sub-floor bond that strengthens the boat and provides a silky smooth and quiet ride. Foam is injected halfway up the side-wall for extreme strength.

### Reinforced Transom

A strong transom ensures the stability of your boat, which is vital for safety. The XT uses a 1.5" thick plywood core sandwiched between aluminum panels. This heavy-duty transom provides all the stability and control you need.

### Ridge-line offers 5X Protection on Hull Seams

Holding each thick hull piece is our "Ridge-line" locking center section. The center extrusion is over 1" thick, providing an extremely solid 1.054 gauge impact zone - 5 times the protection of merely double plated hulls.

### Reverse Angled Chines

Bottom chines significantly improve the stability of your boat. They help reduce roll and sway, ensuring that you have a steadier and more comfortable ride. Reverse angled chines also reduce spray by deflecting water away from the hull.

### Reinforced Bow Ribs

Extra strong bow support reinforced with .100 gauge aluminum bow ribs that eliminate a common weak area found in the front of most boats.





# 6-YEAR WOWRANTY

A warranty that makes you say wow!

Sure we've always had the industry's best warranties on the structural parts of our boats, like the welds, main riveted seams, pontoon tubes, decks and transoms, but what about everything else in your boat? Well, most companies offer a 1 year warranty on the other stuff and some offer up to three years. Although this is very respectable, we figured we'd double that. Legend's 6 Year WOWranty covers most other components for 6 long years. That gives you a lot of worry-free, quality, memory makin' time.

\*For more details, visit  
[www.legendboats.com/wowranty](http://www.legendboats.com/wowranty)



## 3-Year Mercury Warranty

Every Mercury 4-Stroke outboard is backed by a 3-year standard limited warranty to give you peace of mind. Ask us about Mercury Product Protection to extend your Mercury Factory Warranty for up to 8 years.\*



## Lifetime Floor Warranty

A thicker floor means a stronger boat. With 7 layers, of marine grade plywood, each individually-treated, we can offer a lifetime warranty against rotting.\*



## Legend Glide-On 5+1 Year Trailer Warranty

Every Legend Glide-On trailer by Shoreland'r is backed by a 5 year frame warranty and 1-year complete tongue to tail light warranty.\*

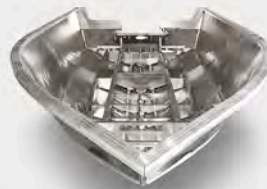

## All-Welded Series Leakproof For Life Warranty

Every Legend All-Welded model carries our exciting and industry-leading Leakproof for Life Warranty. It is remarkably simple. It covers the entire structure of the hull against leaks through the hull for as long as you own the boat. In fact it's the kind of warranty you won't find on any other aluminum boat. Plus it is transferable, giving the second owner up to 10 years of protection.\*



## Legend ProTech 5+1 Year Canvas Warranty

Legend ProTech All-Synthetic Tear and Mildew-Resistant Material is backed by a 5 Year Warranty and guaranteed not to rot or fade for five years. Stitching, zippers, seams and other top components are covered for 1 year.\*

# High-Quality Boats Deserve High-Quality Trailers

Legend Glide-On ShoreArm'r Black  
Powder Coated Trailer

UPGRADE AVAILABLE:  
Legend Galvanized Glide-On Trailer





**Welded tubular steel frame with contoured padded cross members and lower axle**

Made with strong, clean construction—the best frame in the industry. The boat sits lower, providing a more stable centre of gravity which allows for launching and loading in shallower water.



**Self-centering carpeted bunk design**

Launching and loading are effortless. The boat loads straight, stops easily, and is supported over its full length for even weight distribution.

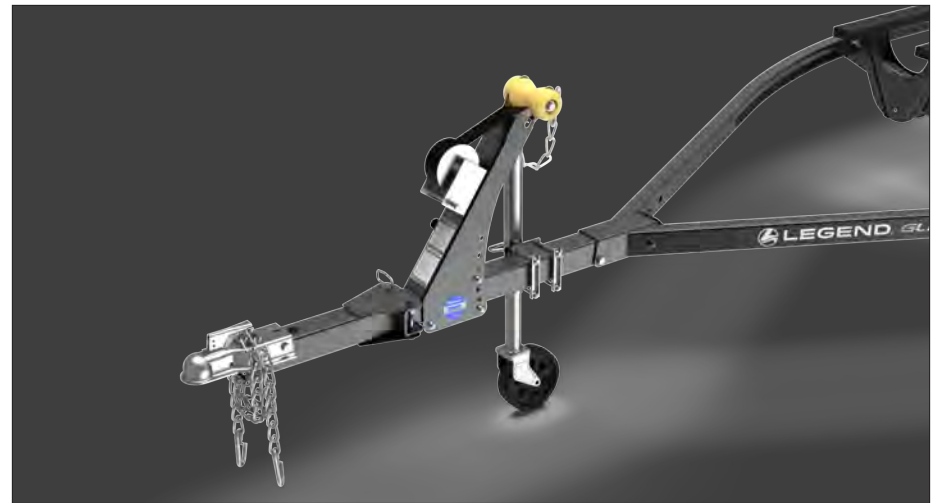

**Reverse angled winch stand with oversized rubber roller**

Prevents unwanted forward movement of the boat during sudden stopping. The roller safely stops the boat during loading and holds the bow in place during transport.

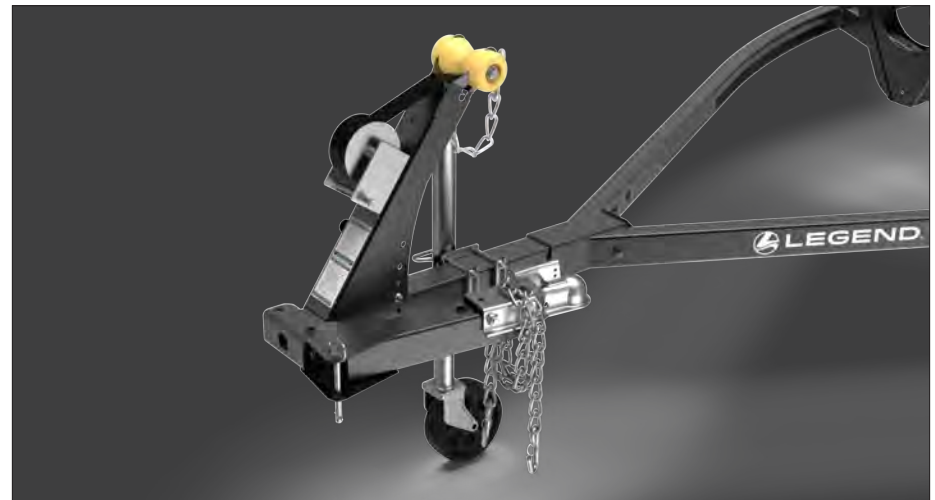

**Space-saving trailer swing tongue**

Reduces trailer length for easier storage and maneuverability, making it more convenient to park and store your boat.

# XT Must-Haves:

## Bow to Stern Cover

17' + 18' **\$1,299** | 19' + 20' **\$1,449**

Our custom-fit bow to stern mooring cover provides complete protection for your Legend boat. Protect your investment and keep your boat looking new.

(Not for winter storage)



### Quick and Easy Ratchet System

Just slide the cover over top of your boat, tighten up the ratchet and you're done. It's that easy!

\*Installation Extra. See Dealer for details.



### Multi-vent Air Circulation System

Vents humidity to let your boat dry quickly.

## Pro Seat **\$299**

Allows for excellent stand-up casting positions. Includes: Pro Seat, auto-locking seat mount and extra-long 25" post.

### ● COMPACT DESIGN

# PRO SEAT KIT GREY



## ErgoMax Diamond Seat Kit **\$749**

- Wood-Free
- Invisible Hinges
- Ergonomically Designed For Extreme Comfort
- Larger Seating Surface
- Folds Flat For A Cleaner Surface

## Legend Fender Kit **\$79**

Everything you need to get started including:

- 3 Legend 5"x20" Fenders
- 3 Fender Loops
- 1 Legend Key Float
- 1 Legend Bag

# LEGEND FENDER KIT BLACK



## SmartCraft Connect **\$299**

Unlock the power of SmartCraft on your smartphone or tablet with the SmartCraft Connect Mobile module. You can wirelessly connect your Mercury engine to the Mercury Marine app, enabling the full suite of VesselView digital performance data, fuel tracking and more on your mobile device.

# 8M0173128

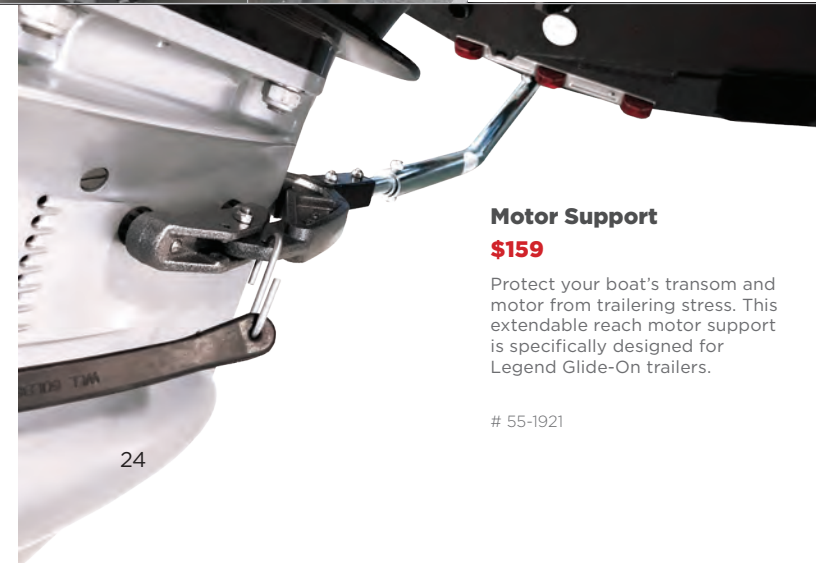

## Motor Support **\$159**

Protect your boat's transom and motor from trailering stress. This extendable reach motor support is specifically designed for Legend Glide-On trailers.

# 55-1921



## Deluxe Safety Kit **\$349**

Everything required by Transport Canada for boating on most lakes.

**Total Value \$378** # DELUXE SAFETY KIT

### BUY THE PACKAGE AND SAVE **\$29**

#### Package includes:

- 4 Universal Legend Life Jackets
- 50 ft Buoyant Heaving Line
- Fire Extinguisher
- 2 Mooring Lines
- Safety Whistle
- Waterproof Flashlight
- 10 lb Anchor with 50 ft Rope
- Telescopic Paddle
- Bailing Bucket

See the Transport Canada Safe Boating Guide for your safety requirements.





## Fish Tech 55 **\$2,999\***

\*Installation Extra. See Dealer for details. #FishTech55Package  
Requires one optional Deep Cycle Battery.

Get the basics covered. The perfect package for the angler wanting to level-up their time on the water.



### POWERDRIVE 55/DSC/MR

Reliable. Capable. And fully able to handle anything a day of fishing brings. PowerDrive™ shows up to the launch ramp every day with big-time technology, trusted power and easy operation.

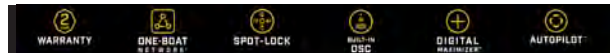

### HELIX 7 CHIRP GPS G4N

Includes Dual Spectrum CHIRP Sonar, AutoChart Live, Internal GPS and Humminbird Basemap built-in. An upgraded high-definition 7" display will give you the best view of the many pre-loaded split screen view options so that you'll never miss a fish.

### RAM MOUNT

Paired with your Helix 7 and installed at the bow, offering precise control of your built-in DSC trolling motor transducer.

### NAVIONICS®+CANADA

Navionics®+ mapping offers integrated marine content that details coastal features plus thousands of rivers, bays and lakes around the world.

## Fish Tech 70 **\$3,499\***

\*Installation Extra. see Dealer for details. #FishTech70Package  
Requires two optional Deep Cycle Battery.

Take your fishing game to the next level with double the battery power to produce 70 lbs. of thrust and extend time on the water.



### POWERDRIVE 70/DSC/MR

Reliable. Capable. And fully able to handle anything a day of fishing brings. PowerDrive™ shows up to the launch ramp every day with big-time technology, trusted power and easy operation.



### HELIX 7 CHIRP GPS G4N

Includes Dual Spectrum CHIRP Sonar, AutoChart Live, Internal GPS and Humminbird Basemap built-in. An upgraded high-definition 7" display will give you the best view of the many pre-loaded split screen view options so that you'll never miss a fish.

### RAM MOUNT

Paired with your Helix 7 and installed at the bow, offering precise control of your built-in DSC trolling motor transducer.

### NAVIONICS®+CANADA

Navionics®+ mapping offers integrated marine content that details coastal features plus thousands of rivers, bays and lakes around the world.

## Fish Tech 80 **\$4,599\***

\*Installation Extra. see Dealer for details. #FishTech80Package  
Requires two optional Deep Cycle Battery.

You're a regular! This package is for the angler looking to make their time on the lake an every weekend kinda' thing.



### TERROVA 80/DSC/WR

How about unlocking more boat control than ever before. Start with Minn Kota's most advanced GPS trolling system, including Spot-Lock®. Top it off with all the thrust you need to take on any water and effortless stow and deploy.



### HELIX 7 CHIRP GPS G4N

Features Dual Spectrum CHIRP Sonar, AutoChart Live, Internal GPS and Humminbird Basemap built-in. An upgraded high-definition 7" display will give you the best view of the many pre-loaded split screen view options so that you'll never miss a fish.

### RAM MOUNT

Paired with your Helix 7 and installed at the bow, offering precise control of your built-in DSC trolling motor transducer.

### NAVIONICS®+ MAPPING

Navionics®+ mapping offers integrated marine content that details coastal features plus thousands of rivers, bays and lakes around the world.



**With a rapidly growing Dealer Network, Legend is taking Canada boating!**

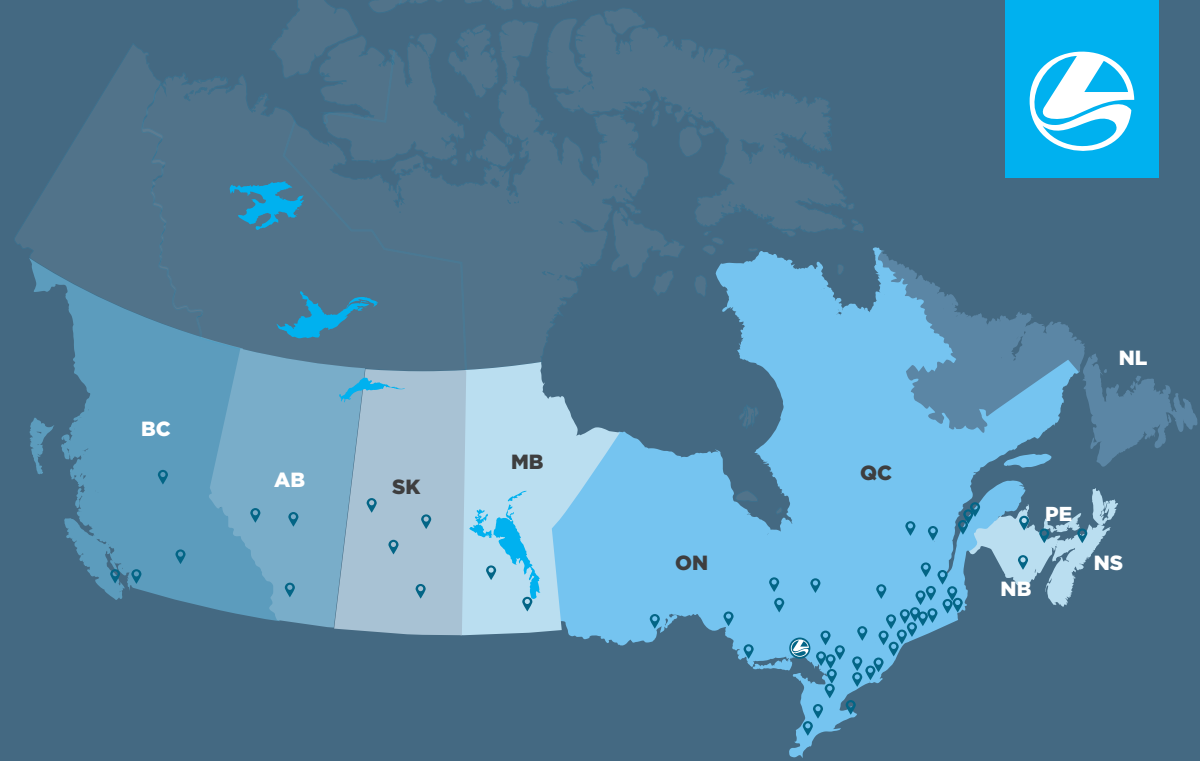

## Freight Charges by Zone.

= Headquarters Whitefish, Ontario

Zone	ON, QC	MB, NB, PE, NS	SK	AB	BC	NL
Boat Package	No Fee	\$1,175	\$1,400	\$2,075	\$2,400	\$3,500

### No Fee Setup and Orientation

All of the components of your boat, motor, and trailer package have been specially chosen for compatibility. The professionals at your authorized Legend Dealership will help you select the proper motor and options for your package. They will then prepare your package to ensure proper and worry-free operation.

### Side console and full windshield models:

The setup includes the following items: control box, shift cables, starting battery, aluminum propeller, outboard installation and set-up. Your dealer will prepare your package and give you a full orientation to ensure trouble-free boating from day one.

\* Freight charges outside of Zone 1 (Ontario and Quebec), licenses, and taxes are extra on all prices. Delivery is available at an additional cost. Payments are calculated with licenses, bank registration charges, and taxes as your down-payment at 8.99% over 1,040 weeks for amounts \$23,000 and higher, 9.99% over 780 weeks for amounts between \$10,000 and \$22,999, and 9.99% over 364 weeks for amounts less than \$10,000 (at time of printing). All financing is OAC. Payments will vary by province. All Choose your power prices are in addition and only available with the purchase of the specific package they are listed with; they are not stand alone motor prices. Towing weights are approximate and are calculated based on a full tank of fuel and 200 pounds for batteries and gear. Speed tests were done with 2 persons, 50 pounds of gear and proper weight distribution. Actual performance may vary. Prices, rates and specifications are subject to change or error. Pictures may show options. Ask for complete details. All illustrations, photographs and specifications in this catalogue are based on the latest product information. See actual boat for complete accuracy. Legend reserves the right to make changes at any time, without notice, in prices, colours, materials, equipment, specifications and models, and to discontinue models or equipment. For information on accessories, contact your local Legend dealer.

Please refer to your provincial laws regarding trailer brakes and ensure that your boat package and tow vehicle comply with the regulations in the provinces you intend to travel in. Brakes may be required in certain circumstances and can be purchased as an option or your trailer model can be upgraded before delivery if brakes are not available on certain trailers. It is your sole responsibility to ensure you comply with all provincial brake requirements for vehicles and also that you always operate your tow vehicle safely. Legend Boats accepts no responsibility with regards to provincial compliance.

At [Legendboats.com](http://Legendboats.com), you'll find a fully-priced electronic version of our catalogue as well as additional pictures and special offers. Always distribute passengers and cargo evenly, wear a PFD and follow the rules for safe boating. Visit: [www.tc.gc.ca/boatingsafety](http://www.tc.gc.ca/boatingsafety)

# Choose Your Power.

Ask your Legend dealer to help you select the Mercury outboard that best suits your needs from the motor choices below. Use the chart that corresponds with the standard engine packaged with your boat model. Simply add the amount to the standard package price to have the motor that is perfect for you.

E = Electric Start  
 L = Long Shaft  
 XL = Extra Long Shaft  
 PT = Power Trim and Tilt  
 CT = Command Thrust

## 17 and 18 XT

FROM A 90 ELPT 4-STROKE TO



+ \$499	+ \$2,499	+ \$3,599	+ \$9,399
90 ELPT CT 4S	115 ELPT 4S	115 ELPT ProXS CT 4S	150L 4S (18 XT Only)

## 19 and 20 XT

FROM A 115 EXLPT 4-STROKE TO



+ \$1,099	+ \$6,899	+ \$19,999	+ \$20,099
115 EXLPT ProXS CT 4S	150XL 4S	150XL ProXS	175XL ProXS (20 XT Only)

Includes Hydraulic Steering and  
 Stainless Steel Propeller



# Our mission is to Create Memories.

Whether we are working on a cool new design, adding an innovative feature, or squeezing in that extra bit of value, all we're thinking about is providing you with the ultimate boating experience and creating memories that will last a lifetime.

Did you know that the Legend headquarters is in Whitefish, Ontario? We have knowledgeable representatives available to answer your questions and direct you to your nearest Dealer. Conveniently reach out via text or call our toll-free number, +1 833-602-5626 and start on the path to finding your new boat.



**Visit our website, chat  
live or find your dealer:**

[legendboats.com](https://www.legendboats.com)





**XF**



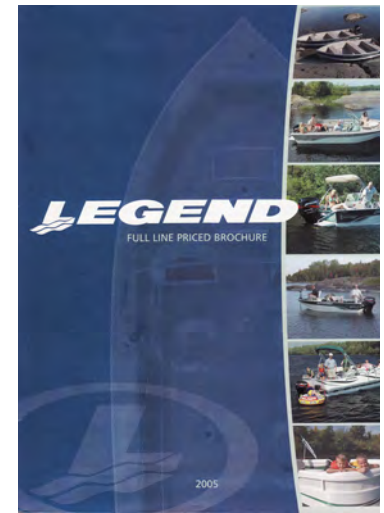
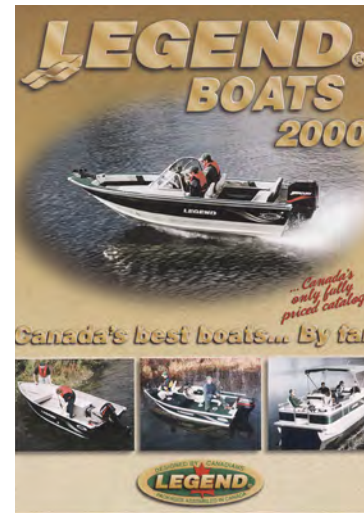
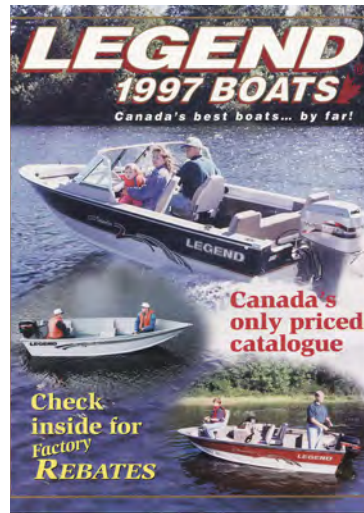
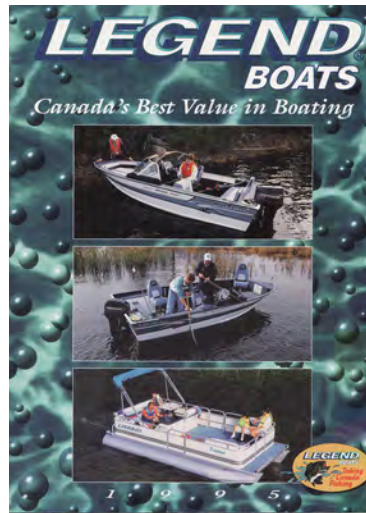

## Are You All-In? CANADA'S ONLY FULLY-PRICED CATALOGUE, SINCE '87.



In a world where we are bombarded with fees, surcharges and extras, wouldn't it be nice if a company would just tell us what it's going to cost up front? Legend Boats is that company. Our prices are All-In!

That's right! No administration fees. No hidden freight fees. No rigging fees. Since 1987, our customers have enjoyed having full package pricing at their fingertips so

they could figure out what their perfect boat or pontoon boat was going to cost right down to the penny. Now, there's no more figuring out. With one simple up-front price, you choose your motor and any options you want, then simply add the taxes. We would have gotten rid of those too but we thought it may have been frowned upon. It really couldn't get any more simple, open, honest or transparent, and we feel that you will appreciate our All-In Pricing.

\*We only print one version of our catalogue for all of Canada. Customers outside of Ontario and Quebec will have a small fee for freight. Prices are listed as of: 01/01/2025, prices are subject to change without notice. For details, visit us at [legendboats.com](http://legendboats.com) for your local, ALL-IN, No-Fee Price including current promotions.

# We do things a little differently.

## Is Legend Canadian?

Yes. We are a Canadian company. We live and play where you do. We understand boating in the unique Canadian wilderness. It's different here, and that's why each and every model is designed by Canadians and built for Canadians. From thicker aluminum to full stand-up tops, we make sure that Mother Nature is no match for your Legend.

## Are Legend boats built in Canada?

Yes and No. Our product developers seek out quality manufacturers throughout North America who can produce in the most cost effective way. By outsourcing component manufacturing and then performing all final assembly, sales, service, and warranty right here in Canada, we ensure that the end product is fit for the Great Canadian outdoors.

## Are the printed catalogue prices MSRP?

No. The printed price is our hassle-free, lowest price. We provide it up front, so there's no need for uncomfortable negotiations. To top it off, aside from a small variance in freight, our low prices are the same across Canada. Now you can make an informed, easy, and no-pressure decision in the comfort of your own home.

## It seems like everyone's warranty is pretty much the same. Is that the case?

Well, at first glance it appears that most companies are offering some sort of lifetime warranty, and it's easy to assume that all warranties are the same, but the devil is in the details. By details, we're talking about the fine print. Our 6 year WOWranty combined with our Lifetime hull warranties give you the absolute best warranty coverage, bar none. Not only do we cover more stuff for longer, but the best part is that everything is taken care of right here in Canada.

## Someone told me Legend boats are underpowered. Is that true?

No. You can actually power your boat with the engine of your choice. Each Legend boat model is designed and packaged with a Mercury motor large enough to get you and a friend on the water to experience the boating lifestyle with minimal investment. We understand that everyone's boating needs are different, and that the packaged motor may not suit your needs. That's why we make it easy to choose the perfect Mercury outboard to power all of your on-water activities. So, whether you want to troll all day, bring the kids tubing, cruise with your family or pull two water skiers, we'll help you select the engine that's just right.

## Why do you only package your boats with Mercury outboards?

We partner exclusively with Mercury because of their proven quality, value, reliability, service and features. With the large number of clients we help onto the water each year in Canada, other outboard manufacturers would love us to package with their brand. Mercury appreciates our business so much, they offer us exclusive savings that we simply pass on to you. That's how we package with the oldest, largest, number one outboard engine brand at such an incredible price. On top of a great price, by purchasing a complete custom package you'll enjoy consistent performance and one-location servicing.

## We give you the most standard equipment.

We've outfitted our boats with more equipment for less. Things that you would have to pay thousands of dollars extra for with other brands are simply part of our value-packed models. Many of our Legend packages have standard features like Dura-deck vinyl floors, automatic bilge pumps, and a bunch of other great stuff that is optional in other brands. When it comes to value, we're proud to say that nobody compares. We have more equipment for less than any other brand!

## You claim your quality is good but your prices are affordable. How is that possible?

You get what you pay for right? Well in most cases, yes. But at Legend, we never sacrifice quality in order to reduce cost. Our use of quality brand name products in our packages such as Shoreland'r trailers, Minn Kota and Garmin trolling motors and Mercury outboards - the largest brands in boating - speak for themselves. To keep prices low, we build fewer models in higher volumes and package each model with the same popular features. By purchasing thousands of each component, such as full stand-up tops, fish finders and GPS', we can offer you unbelievably high quality at affordable prices. That's how we do it.

## Why doesn't everyone put pricing in their catalogues?

That's a great question. We don't know. It could be because it takes a lot more work and effort to include all of the details required when you're sharing a price. Or, perhaps nobody else does it because they have something to hide. But we're only guessing. All we know is that we're so confident that we offer the absolute best value in Canada that we publish our complete, hassle-free, all-In pricing for all to see. You can find our prices in our full line brochure, on our extensive website and in all of our advertisements. We even print the pricing of our most popular options so you can "build" your own Legend. Nothing is hidden and it's all in Canadian dollars. We've done the work for you and given you our lowest price right up front.



## 2025 XF Quick Guide

Available in 16' and 18'



Moonshot Green and Tangerine Orange with Steel Grey furniture



## XF Features

### FULL WINDSHIELD OR SIDE CONSOLE.



**SAME LEGENDARY BOAT. TWO WAYS TO MAKE IT YOURS.**



**Full Windshield**

- Better suited for various weather conditions
- Additional storage throughout passenger-side console
- Enhanced passenger comfort
- Ability to add full stand-up-top
- EZ-Flip 50/50 Split Converta-Bench
- 114L Aerated Livewell
- 4-on-the-floor seat base configuration

**Side Console**

- Seamless access from bow to stern
- Panoramic visibility
- Enhanced legroom for passengers
- EZ-Flip 50/50 Split Converta-Bench
- 114L Aerated Livewell
- 4-on-the-floor seat base configuration

### FULL STAND-UP ALL-WEATHER TOP

Add this optional full stand-up top to extend your season and escape the elements. See your dealer for prices.



### READY TO REEL.

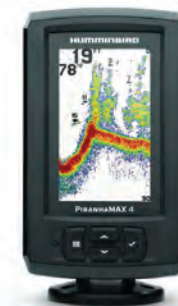

Humminbird PiranhaMAX 4  
Standard on all XF Models.

### SEE MORE, CATCH MORE.



Take your XF to the next level.  
Upgrade to a bigger screen.

## Room to reel.

The Ultimate Bow Casting Deck takes center stage, offering not just a wide, open space for fishing and lounging, but also ample storage hidden beneath.





## Everything in its place, and then some.

Your fishing essentials, all packed in one. With lockable side rod storage, an aerated bow livewell, and in-floor rod storage, the XF keeps your tools in your arsenal and always within reach. Ready for whatever the day brings.



Lockable Side Storage



114L Aerated Bow Livewell



In-floor Rod Storage\*  
\*18 XF Full Windshield only





Full-Vu Console



1 wireless bluetooth PX7 waterproof speaker with magnetic base



Illuminated Switches and Gauges



Passenger Console\*  
\*16 and 18 XF Full Windshield Models only



**Ready to cast, ready to relax.**

**The EZ-Flip 50/50 Split Extenda-Deck  
Converta-Bench**

Transform your casting deck into a dual-seat bench in seconds—perfect for fishing, cruising, or relaxing by the water. Paired with the rear swim platform, it's the ultimate setup for fun and adventure. So simple, even the kids can do it!



## Seats when you need them, space when you don't.

Whether you're reeling in the big one or kicking back with company, the XF's flexible seating has you covered. Add swivel chairs for comfort or remove them for a casting deck that's all yours.

### 4-on-the-floor seat base configuration and flex-seating

16XF x6 seat bases  
18XF x7 seat bases

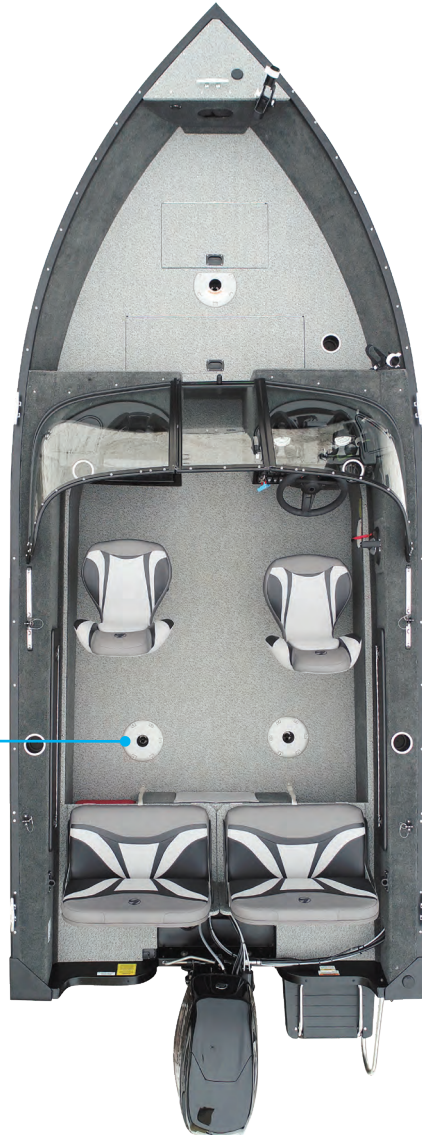

Flexible Bow Seating

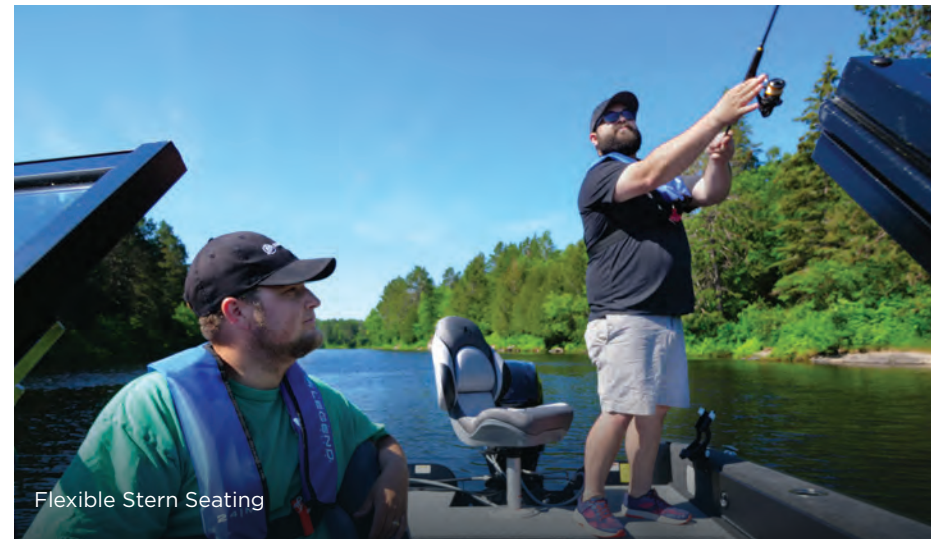

Flexible Stern Seating

**ALL-IN  
PRICE**  
NO EXTRA FEES\*

# XF-SERIES

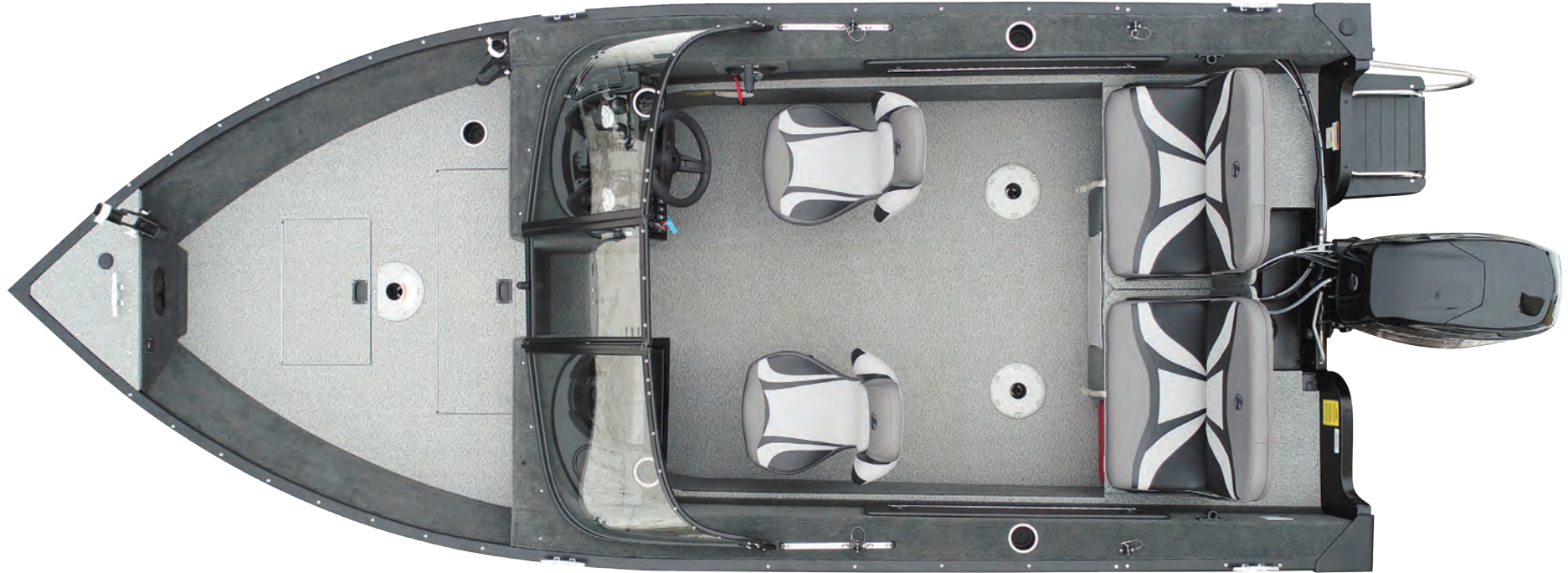

16 XF Shown

## SPECIFICATIONS

	16 XF SC	16 XF	18 XF
Length	16'6"	16'6"	17'6"
Beam	82"	82"	90"
Hull Depth	37"	37"	41"
Inside Depth	25"	25"	26"
Bottom Width	69"	69"	76"
Aluminum Thickness	0.100	0.100	0.100
Maximum Horsepower	90	90	150

	16 XF SC	16 XF	18 XF
Maximum Capacity(lbs)	1393	1393	1744
Hull Weight (lbs)	830	1015	1376
Towing Weight (lbs)	1730	1920	2484
Package Length	18'4"	18'4"	19'9"
Package Width	82"	82"	92"
Gas Tank	Portable	Portable	95L (25US gal)





## 16 XF SC

**\$77** Per Week | **\$36,999\***

With Mercury 50 ELPT 4S and Glide-On Trailer



Build me!

### Choose Your Power

● Fish/Cruise ● Tube ● Ski

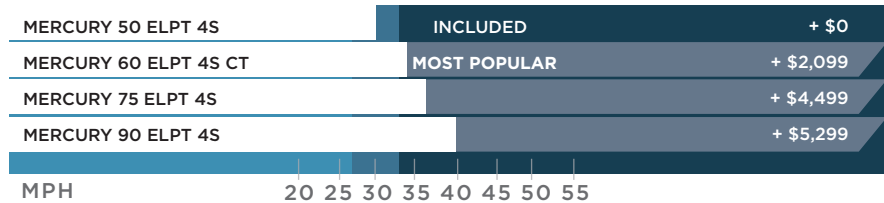

## 16 XF

**\$85** Per Week | **\$40,999\***

With Mercury 60 ELPT 4S and Glide-On Trailer



Build me!

### Choose Your Power

● Fish/Cruise ● Tube ● Ski

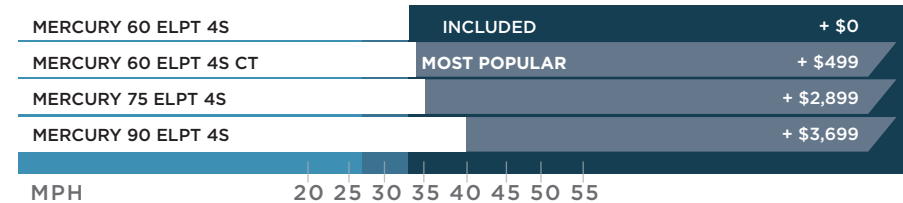

## 18 XF

**\$108** Per Week | **\$51,999\***

With Mercury 90 ELPT 4S and Glide-On Trailer



Build me!

### Choose Your Power

● Fish/Cruise ● Tube ● Ski

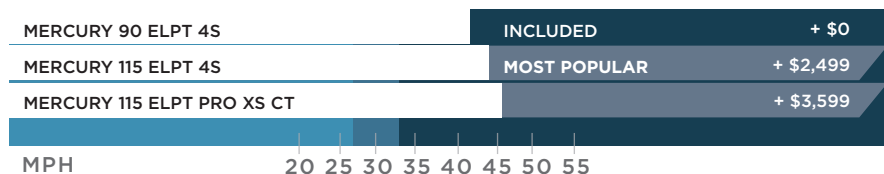

## KEY STANDARD FEATURES

### 16 XF SC:

- EZ-Flip 50/50 Extenda-Deck Converta-Bench
- 2 ErgoMax 360° Swivel Chairs
- Large front casting deck with oversized storage
- Deluxe Full-Vu Console
- 114 Litres aerated bow livewell

### 16 XF: Everything listed, plus

Passenger Console

### 18 XF: Everything listed, plus

In-floor Rod Storage

**WE'VE GOT YOU COVERED**

 <b>.100 Gauge</b> <small>Perfect-Flex Aluminum</small>	 <b>All-Welded</b> <small>Aluminum Hull</small>	 <b>Leakproof + 6 Year</b> <small>For Life Warranty</small>
---	---	---

## XF Surprisingly Included Equipment

### PREFERRED EQUIPMENT PACKAGE

16XF:	Value:
Space-Saving Trailer Swing Tongue	\$499
Humminbird PiranhaMAX 4 Fish/Depth Finder	\$399
Swim Platform with Fold-Down Step(s)	\$399
Wireless Bluetooth IPX7 Waterproof Speaker	\$338

---

**16 Value: \$1,635**

#### 16XF SC:

Includes all of the above, plus a removable windscreen

---

**16 SC Value: \$2,104**

#### 18XF:

Includes all of the above, plus Tilt Steering

---

**18 Value: \$2,703**





## 16 XF SC

### Specifications

Length 16'6"  
 Beam 82"  
 Towing Weight 1730lbs  
 Hull Weight 830lbs  
 Max HP 90

### Key Standard Features

EZ-Flip 50/50 Extenda-Deck  
 Converta-Bench  
 2 ErgoMax 360° Swivel Chairs  
 Large front casting deck with oversized storage  
 Deluxe Full-Vu Console  
 114 Litres Aerated Bow Livewell  
 -  
 -



## 16 XF

### Specifications

Length 16'6"  
 Beam 82"  
 Towing Weight 1920lbs  
 Hull Weight 1015lbs  
 Max HP 90

### Key Standard Features

EZ-Flip 50/50 Extenda-Deck  
 Converta-Bench  
 2 ErgoMax 360° Swivel Chairs  
 Large front casting deck with oversized storage  
 Deluxe Full-Vu Console  
 114 Litres Aerated Bow Livewell  
 Passenger Console  
 -



## 18 XF

### Specifications

Length 17'6"  
 Beam 90"  
 Towing Weight 2484lbs  
 Hull Weight 1376lbs  
 Max HP 150

### Key Standard Features

EZ-Flip 50/50 Extenda-Deck  
 Converta-Bench  
 2 ErgoMax 360° Swivel Chairs  
 Large front casting deck with oversized storage  
 Deluxe Full-Vu Console  
 114 Litres Aerated Bow Livewell  
 Passenger Console  
 In-Floor Rod Storage



## Built to Last. Leakproof for Life. Guaranteed.

### Super-Thick .100 Gauge One-Piece Seamless Hull

With this seamless hull, your Legend boat will last longer with no potential for centre-seam leaks. While our .100 Gauge hulls provide unmatched thickness, our use of Legend's H34 PerfectFlex aluminum provides the best combination of flexibility and strength.

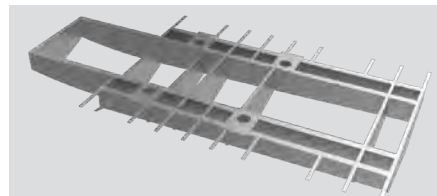

### Torsion Beam Energy Transfer + Intelliflex Hull

Provides your boat with necessary flexing, while remaining light and strong. Thanks to the built-in torsion beam energy system, the XF's hull flexes, adapts, and dissipates wave energy evenly throughout the hull, preventing problem areas from forming over time.

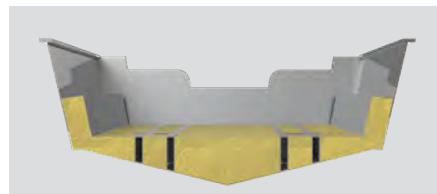

### Quiet Core Injected Foam

Our spray foamed hulls help with sound deadening and buoyancy, adding to the overall luxury and performance of our boats. Not only will every Legend float even when filled with water, the injected foam creates a solid sub-floor bond that strengthens the boat and provides a silky smooth and quiet ride. Foam is injected halfway up the side-wall for extreme strength.

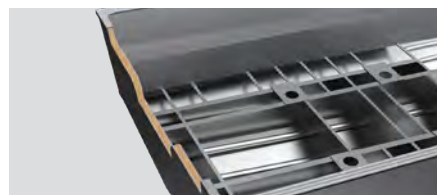

### Reinforced Transom

A strong transom ensures the stability of your boat, which is vital for safety. The XF uses a 1.5" thick plywood core sandwiched between aluminum panels. This heavy-duty transom provides all the stability and control you need.

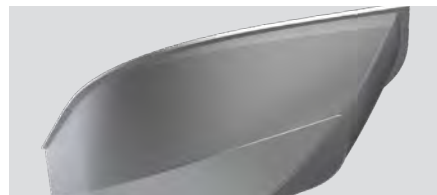

### Ridge-line offers 5X Protection on Hull Seams

Holding each thick hull piece is our "Ridge-line" locking center section. The center extrusion is over 1" thick, providing an extremely solid 1.054 gauge impact zone - 5 times the protection of merely double plated hulls.

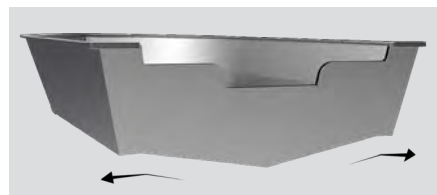

### Reverse Angled Chines

Bottom chines significantly improve the stability of your boat. They help reduce roll and sway, ensuring that you have a steadier and more comfortable ride. Reverse angled chines also reduce spray by deflecting water away from the hull.

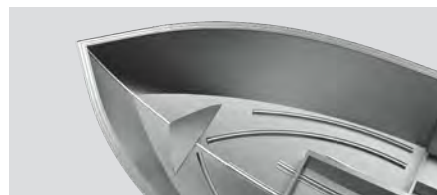

### Reinforced Bow Ribs

Extra strong bow support reinforced with .100 gauge aluminum bow ribs that eliminate a common weak area found in the front of most boats.

# 6-YEAR WOWRANTY

A warranty that makes you say wow!

Sure we've always had the industry's best warranties on the structural parts of our boats, like the welds, main riveted seams, pontoon tubes, decks and transoms, but what about everything else in your boat? Well, most companies offer a 1 year warranty on the other stuff and some offer up to three years. Although this is very respectable, we figured we'd double that. Legend's 6 Year WOWranty covers most other components for 6 long years. That gives you a lot of worry-free, quality, memory makin' time.

\*For more details, visit  
[www.legendboats.com/wowranty](http://www.legendboats.com/wowranty)



## 3-Year Mercury Warranty

Every Mercury 4-Stroke outboard is backed by a 3-year standard limited warranty to give you peace of mind. Ask us about Mercury Product Protection to extend your Mercury Factory Warranty for up to 8 years.\*



## Lifetime Floor Warranty

A thicker floor means a stronger boat. With 7 layers, of marine grade plywood, each individually-treated, we can offer a lifetime warranty against rotting.\*



## Legend Glide-On 5+1 Year Trailer Warranty

Every Legend Glide-On trailer by Shoreland'r is backed by a 5 year frame warranty and 1-year complete tongue to tail light warranty.\*

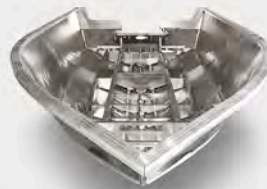

## All-Welded Series Leakproof For Life Warranty

Every Legend All-Welded model carries our exciting and industry-leading Leakproof for Life Warranty. It is remarkably simple. It covers the entire structure of the hull against leaks through the hull for as long as you own the boat. In fact it's the kind of warranty you won't find on any other aluminum boat. Plus it is transferable, giving the second owner up to 10 years of protection.\*



## Legend ProTech 5+1 Year Canvas Warranty

Legend ProTech All-Synthetic Tear and Mildew-Resistant Material is backed by a 5 Year Warranty and guaranteed not to rot or fade for five years. Stitching, zippers, seams and other top components are covered for 1 year.\*



## High-Quality Boats Deserve High-Quality Trailers

**Legend Glide-On ShoreArm'r Black  
Powder Coated Trailer**

*Trailer for 18XF Featured*

**UPGRADE AVAILABLE:**  
Legend Galvanized Glide-On Trailer

Trailer for 18XF Featured

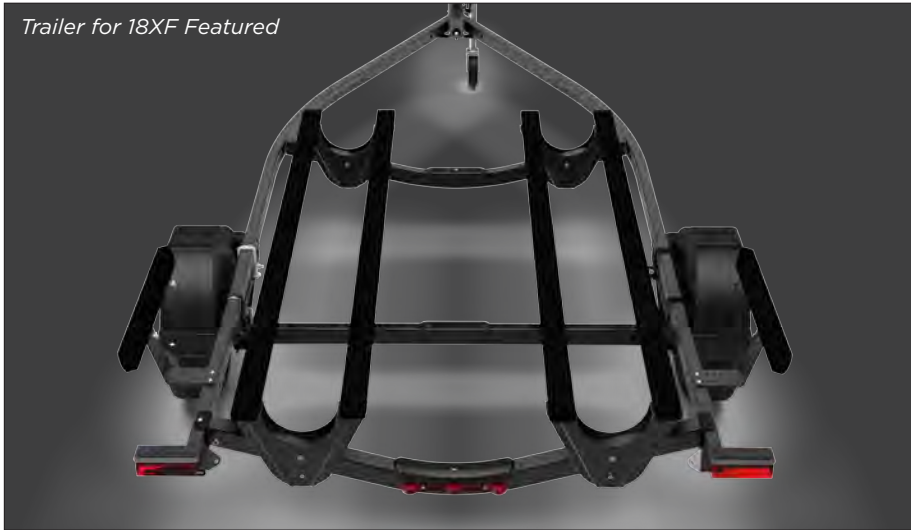

**Welded tubular steel frame with contoured padded cross members and lower axle**

Made with strong, clean construction—the best frame in the industry. The boat sits lower, providing a more stable centre of gravity which allows for launching and loading in shallower water.

Trailer for 18XF Featured

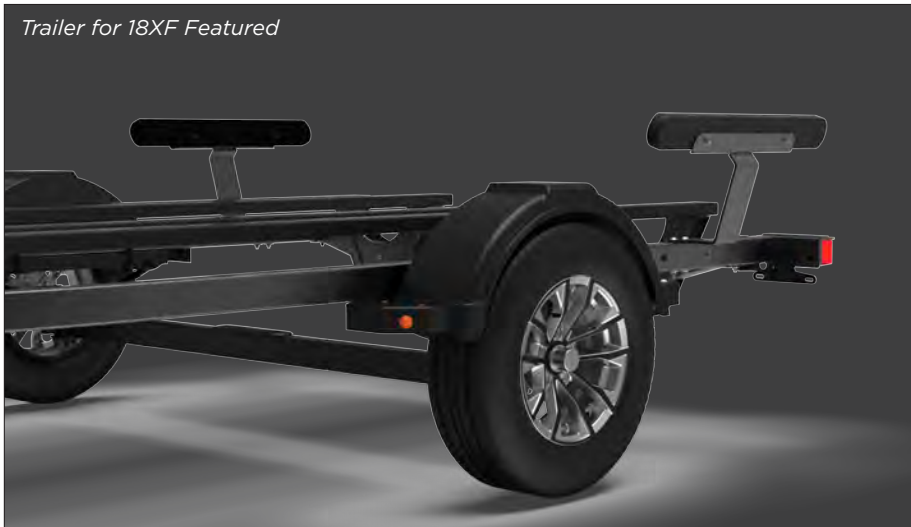

**Self-centering carpeted bunk design**

Launching and loading are effortless. The boat loads straight, stops easily, and is supported over its full length for even weight distribution.

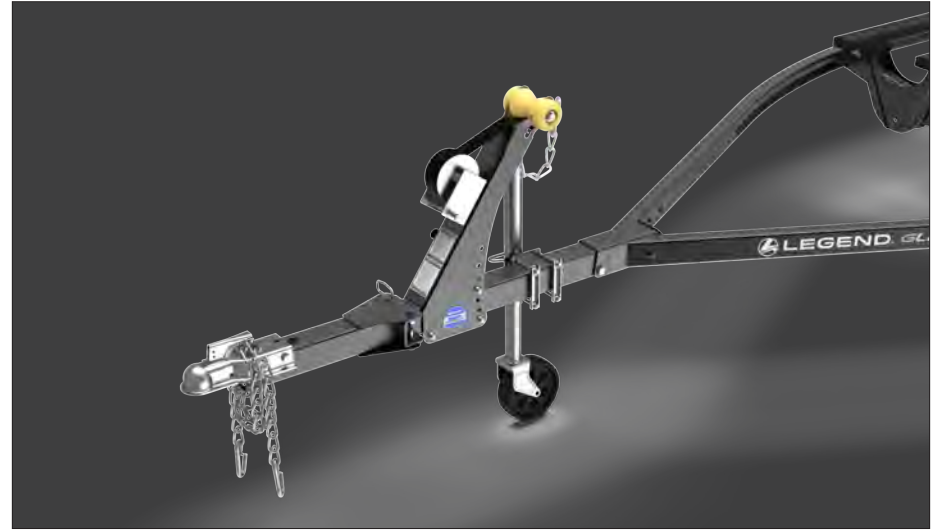

**Reverse angled winch stand with oversized rubber roller**

Prevents unwanted forward movement of the boat during sudden stopping. The roller safely stops the boat during loading and holds the bow in place during transport.



**Space-saving trailer swing tongue**

Reduces trailer length for easier storage and maneuverability, making it more convenient to park and store your boat.

# XF Must-Haves:

## Bow to Stern Cover

16 SC **\$1,049** | 16' **\$1,199** | 18' **\$1,299**

Our custom-fit bow to stern mooring cover provides complete protection for your Legend boat. Protect your investment and keep your boat looking new.

(Not for winter storage)



### Quick and Easy Ratchet System

Just slide the cover over top of your boat, tighten up the ratchet and you're done. It's that easy!



### Multi-vent Air Circulation System

Vents humidity to let your boat dry quickly.

\*Installation Extra. See Dealer for details.

## ErgoMax Swivel Chair Kit **\$749**

Extra comfort for your co-captain.

- Wood-Free
- Invisible Hinges
- Ergonomically Designed For Extreme Comfort
- Larger Seating Surface
- Folds Flat For A Cleaner Surface



# ERGOMAX SEAT KIT

## Seat Slider **\$299**

This slider has a gear tooth lock mechanism, locks solidly, disengages easily and rides smoothly on acetal linear bearings.

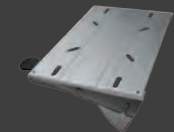

# 35600281

## Pro Seat **\$299**

Allows for excellent stand-up casting positions. Includes: Pro Seat, auto-locking seat mount and extra-long 25" post.

- **COMPACT DESIGN**

# PRO SEAT KIT GREY



## Legend Fender Kit **\$79**

Everything you need to get started including:

- 3 Legend 5"x20" Fenders
- 3 Fender Loops
- 1 Legend Key Float
- 1 Legend Bag

# LEGEND FENDER KIT BLACK



## Upgrade your straps **\$99**

The TowBetter Auto Retractable Tie Downs. Includes a retractable ratchet nylon strap, retracts for convenient storage. S-hooks with a vinyl coating protects the aluminum paint finish of the boat. All necessary hardware is included.

# BTDP3B



## Deluxe Safety Kit **\$349**

Everything required by Transport Canada for boating on most lakes.

**Total Value \$378** # DELUXE SAFETY KIT

### BUY THE PACKAGE AND SAVE **\$29**

#### Package includes:

- 4 Universal Legend Life Jackets
- 50 ft Buoyant Heaving Line
- Fire Extinguisher
- 2 Mooring Lines
- Safety Whistle
- Waterproof Flashlight
- 10 lb Anchor with 50 ft Rope
- Telescopic Paddle
- Bailing Bucket

See the Transport Canada Safe Boating Guide for your safety requirements.



## Motor Support **\$159**

Protect your boat's transom and motor from trailering stress. This extendable reach motor support is specifically designed for Legend Glide-On trailers.

# 55-1921

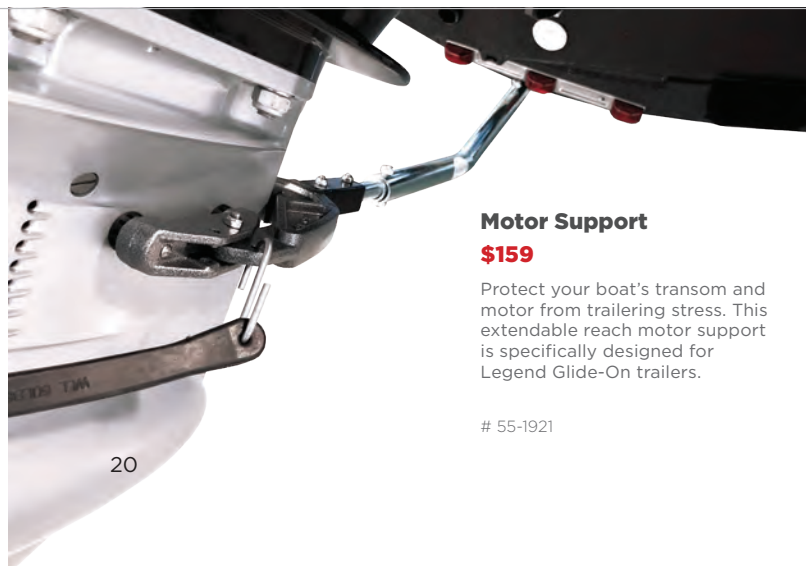





## Fish Tech 55 **\$2,999\***

\*Installation Extra. see Dealer for details. #FishTech55Package  
Requires one optional Deep Cycle Battery.

Get the basics covered. The perfect package for the angler wanting to level-up their time on the water.



### POWERDRIVE 55/DSC/MR

Reliable. Capable. And fully able to handle anything a day of fishing brings. PowerDrive™ shows up to the launch ramp every day with big-time technology, trusted power and easy operation.

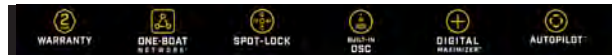

### HELIX 7 CHIRP GPS G4N

Includes Dual Spectrum CHIRP Sonar, AutoChart Live, Internal GPS and Humminbird Basemap built-in. An upgraded high-definition 7" display will give you the best view of the many pre-loaded split screen view options so that you'll never miss a fish.

### RAM MOUNT

Paired with your Helix 7 and installed at the bow, offering precise control of your built-in DSC trolling motor transducer.

### NAVIONICS®+CANADA

Navionics®+ mapping offers integrated marine content that details coastal features plus thousands of rivers, bays and lakes around the world.

## Fish Tech 70 **\$3,499\***

\*Installation Extra. see Dealer for details. #FishTech70Package  
Requires two optional Deep Cycle Battery.

Take your fishing game to the next level with double the battery power to produce 70 lbs. of thrust and extended time on the water.



### POWERDRIVE 70/DSC/MR

Reliable. Capable. And fully able to handle anything a day of fishing brings. PowerDrive™ shows up to the launch ramp every day with big-time technology, trusted power and easy operation.



### HELIX 7 CHIRP GPS G4N

Includes Dual Spectrum CHIRP Sonar, AutoChart Live, Internal GPS and Humminbird Basemap built-in. An upgraded high-definition 7" display will give you the best view of the many pre-loaded split screen view options so that you'll never miss a fish.

### RAM MOUNT

Paired with your Helix 7 and installed at the bow, offering precise control of your built-in DSC trolling motor transducer.

### NAVIONICS®+CANADA

Navionics®+ mapping offers integrated marine content that details coastal features plus thousands of rivers, bays and lakes around the world.

## See more, catch more. Standalone Upgrades

### POWERDRIVE 45 MR 54" **\$1,399**

\*Installation Extra. see Dealer for details.  
Requires one optional Deep Cycle Battery.

Reliable. Capable. And fully able to handle anything a day of fishing brings. PowerDrive™ shows up to the launch ramp every day with big-time technology, trusted power and easy operation.



- 12 Volt, 45 lbs thrust, 54" shaft
- GPS-enabled model shipped with micro remote
- Fully compatible with Humminbird fish finder units
- Phone App Compatible (Free Download)
- Push to Test Battery Meter
- Digital Maximizer
- Power Prop



### Helix 5 CHIRP GPS G3 **\$489**

#411660-1



### Helix 7 CHIRP GPS G4N **\$1,049**

#411630-1





**With a rapidly growing Dealer Network, Legend is taking Canada boating!**

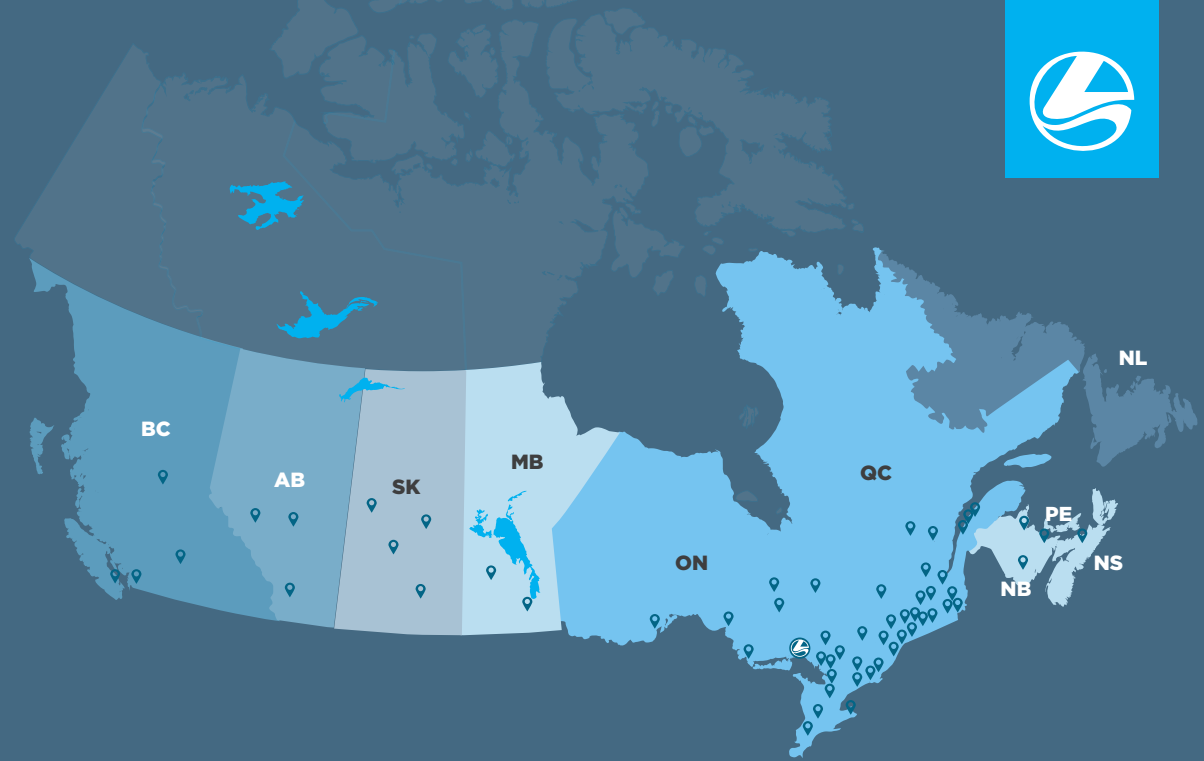

## Freight Charges by Zone.

= Headquarters Whitefish, Ontario

Zone	ON, QC	MB, NB, PE, NS	SK	AB	BC	NL
Boat Package	No Fee	\$1,175	\$1,400	\$2,075	\$2,400	\$3,500

### No Fee Setup and Orientation

All of the components of your boat, motor, and trailer package have been specially chosen for compatibility. The professionals at your authorized Legend Dealership will help you select the proper motor and options for your package. They will then prepare your package to ensure proper and worry-free operation.

### Side console and full windshield models:

The setup includes the following items: control box, shift cables, starting battery, aluminum propeller, outboard installation and set-up. Your dealer will prepare your package and give you a full orientation to ensure trouble-free boating from day one.

\* Freight charges outside of Zone 1 (Ontario and Quebec), licenses, and taxes are extra on all prices. Delivery is available at an additional cost. Payments are calculated with licenses, bank registration charges, and taxes as your down-payment at 8.99% over 1,040 weeks for amounts \$23,000 and higher, 9.99% over 780 weeks for amounts between \$10,000 and \$22,999, and 9.99% over 364 weeks for amounts less than \$10,000 (at time of printing). All financing is OAC. Payments will vary by province. All Choose your power prices are in addition and only available with the purchase of the specific package they are listed with; they are not stand alone motor prices. Towing weights are approximate and are calculated based on a full tank of fuel and 200 pounds for batteries and gear. Speed tests were done with 2 persons, 50 pounds of gear and proper weight distribution. Actual performance may vary. Prices, rates and specifications are subject to change or error. Pictures may show options. Ask for complete details. All illustrations, photographs and specifications in this catalogue are based on the latest product information. See actual boat for complete accuracy. Legend reserves the right to make changes at any time, without notice, in prices, colours, materials, equipment, specifications and models, and to discontinue models or equipment. For information on accessories, contact your local Legend dealer.

Please refer to your provincial laws regarding trailer brakes and ensure that your boat package and tow vehicle comply with the regulations in the provinces you intend to travel in. Brakes may be required in certain circumstances and can be purchased as an option or your trailer model can be upgraded before delivery if brakes are not available on certain trailers. It is your sole responsibility to ensure you comply with all provincial brake requirements for vehicles and also that you always operate your tow vehicle safely. Legend Boats accepts no responsibility with regards to provincial compliance.

At [Legendboats.com](http://Legendboats.com), you'll find a fully-priced electronic version of our catalogue as well as additional pictures and special offers. Always distribute passengers and cargo evenly, wear a PFD and follow the rules for safe boating. Visit: [www.tc.gc.ca/boatingsafety](http://www.tc.gc.ca/boatingsafety)

# Choose Your Power.

Ask your Legend dealer to help you select the Mercury outboard that best suits your needs from the motor choices below. Use the chart that corresponds with the standard engine packaged with your boat model. Simply add the amount to the standard package price to have the motor that is perfect for you.

E = Electric Start  
 L = Long Shaft  
 PT = Power Trim and Tilt  
 CT = Command Thrust

## 16 XF SC

FROM A 50 ELPT 4-STROKE TO



+ \$499	+ \$1,599	+ \$2,099	+ \$5,299
50 ELPT CT 4S	60 ELPT 4S	60 ELPT CT 4S	90 ELPT 4S

## 16 XF

FROM A 60 ELPT 4-STROKE TO



+ \$499	+ \$2,899	+ \$3,699
60 ELPT CT 4S	75 ELPT 4S	90 ELPT 4S

## 18 XF

FROM A 90 ELPT 4-STROKE TO



+ \$499	+ \$2,499	+ \$3,599	+ \$9,399
90 ELPT CT 4S	115 ELPT 4S	115 ELPT ProXS CT 4S	150L 4S



# Our mission is to Create Memories.

Whether we are working on a cool new design, adding an innovative feature, or squeezing in that extra bit of value, all we're thinking about is providing you with the ultimate boating experience and creating memories that will last a lifetime.

Did you know that the Legend headquarters is in Whitefish, Ontario? We have knowledgeable representatives available to answer your questions and direct you to your nearest Dealer. Conveniently reach out via text or call our toll-free number, +1 833-602-5626 and start on the path to finding your new boat.



**Visit our website, chat  
live or find your dealer:**  
[legendboats.com](http://legendboats.com)





# R-SERIES

2025 Fully-Priced Buying Guide | Boat Show Edition

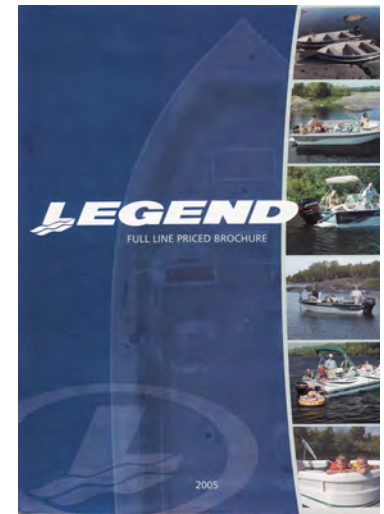
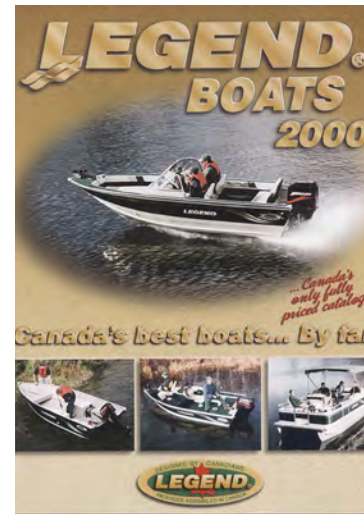
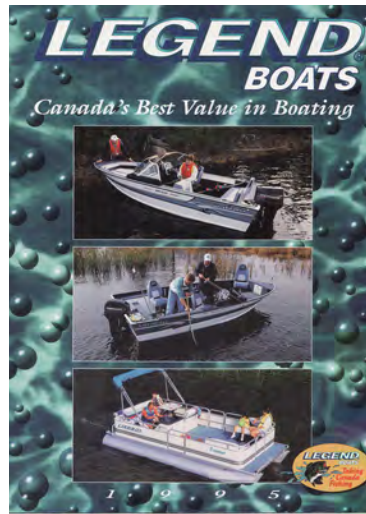

## Are You All-In? CANADA'S ONLY FULLY-PRICED CATALOGUE, SINCE '87.



In a world where we are bombarded with fees, surcharges and extras, wouldn't it be nice if a company would just tell us what it's going to cost up front? Legend Boats is that company. Our prices are All-In!

That's right! No administration fees. No hidden freight fees. No rigging fees. Since 1987, our customers have enjoyed having full package pricing at their fingertips so

they could figure out what their perfect boat or pontoon boat was going to cost right down to the penny. Now, there's no more figuring out. With one simple up-front price, you choose your motor and any options you want, then simply add the taxes. We would have gotten rid of those too but we thought it may have been frowned upon. It really couldn't get any more simple, open, honest or transparent, and we feel that you will appreciate our All-In Pricing.

\*We only print one version of our catalogue for all of Canada. Customers outside of Ontario and Quebec will have a small fee for freight. Prices are listed as of: 01/01/2025, prices are subject to change without notice. For details, visit us at [legendboats.com](http://legendboats.com) for your local, ALL-IN, No-Fee Price including current promotions.

# We do things a little differently.

## Is Legend Canadian?

Yes. We are a Canadian company. We live and play where you do. We understand boating in the unique Canadian wilderness. It's different here, and that's why each and every model is designed by Canadians and built for Canadians. From thicker aluminum to full stand-up tops, we make sure that Mother Nature is no match for your Legend.

## Are Legend boats built in Canada?

Yes and No. Our product developers seek out quality manufacturers throughout North America who can produce in the most cost effective way. By outsourcing component manufacturing and then performing all final assembly, sales, service, and warranty right here in Canada, we ensure that the end product is fit for the Great Canadian outdoors.

## Are the printed catalogue prices MSRP?

No. The printed price is our hassle-free, lowest price. We provide it up front, so there's no need for uncomfortable negotiations. To top it off, aside from a small variance in freight, our low prices are the same across Canada. Now you can make an informed, easy, and no-pressure decision in the comfort of your own home.

## It seems like everyone's warranty is pretty much the same. Is that the case?

Well, at first glance it appears that most companies are offering some sort of lifetime warranty, and it's easy to assume that all warranties are the same, but the devil is in the details. By details, we're talking about the fine print. Our 6 year WOWranty combined with our Lifetime hull warranties give you the absolute best warranty coverage, bar none. Not only do we cover more stuff for longer, but the best part is that everything is taken care of right here in Canada.

## Someone told me Legend boats are underpowered. Is that true?

No. You can actually power your boat with the engine of your choice. Each Legend boat model is designed and packaged with a Mercury motor large enough to get you and a friend on the water to experience the boating lifestyle with minimal investment. We understand that everyone's boating needs are different, and that the packaged motor may not suit your needs. That's why we make it easy to choose the perfect Mercury outboard to power all of your on-water activities. So, whether you want to troll all day, bring the kids tubing, cruise with your family or pull two water skiers, we'll help you select the engine that's just right.

## Why do you only package your boats with Mercury outboards?

We partner exclusively with Mercury because of their proven quality, value, reliability, service and features. With the large number of clients we help onto the water each year in Canada, other outboard manufacturers would love us to package with their brand. Mercury appreciates our business so much, they offer us exclusive savings that we simply pass on to you. That's how we package with the oldest, largest, number one outboard engine brand at such an incredible price. On top of a great price, by purchasing a complete custom package you'll enjoy consistent performance and one-location servicing.

## We give you the most standard equipment.

We've outfitted our boats with more equipment for less. Things that you would have to pay thousands of dollars extra for with other brands are simply part of our value-packed models. Many of our Legend packages have standard features like Dura-deck vinyl floors, automatic bilge pumps, and a bunch of other great stuff that is optional in other brands. When it comes to value, we're proud to say that nobody compares. We have more equipment for less than any other brand!

## You claim your quality is good but your prices are affordable. How is that possible?

You get what you pay for right? Well in most cases, yes. But at Legend, we never sacrifice quality in order to reduce cost. Our use of quality brand name products in our packages such as Shoreland'r trailers, Minn Kota and Garmin trolling motors and Mercury outboards - the largest brands in boating - speak for themselves. To keep prices low, we build fewer models in higher volumes and package each model with the same popular features. By purchasing thousands of each component, such as full stand-up tops, fish finders and GPS', we can offer you unbelievably high quality at affordable prices. That's how we do it.

## Why doesn't everyone put pricing in their catalogues?

That's a great question. We don't know. It could be because it takes a lot more work and effort to include all of the details required when you're sharing a price. Or, perhaps nobody else does it because they have something to hide. But we're only guessing. All we know is that we're so confident that we offer the absolute best value in Canada that we publish our complete, hassle-free, all-In pricing for all to see. You can find our prices in our full line brochure, on our extensive website and in all of our advertisements. We even print the pricing of our most popular options so you can "build" your own Legend. Nothing is hidden and it's all in Canadian dollars. We've done the work for you and given you our lowest price right up front.



## 2025 R Series Quick Guide

Available in 12' - 16'



R15



**ProSport**  
(16 ProSport SC Shown)



**Ultralite and Widebody**  
(Shown with optional motor and trailer)



## R-Series Feature Breakdown

### Ultralite and Widebody



Split Rear Seats



Integrated Rod Holder



Integrated grab and mooring handles

### ProSport LS and SC



Humminbird PiranhaMAX 4



Lockable Rod Box



Bow Casting Deck

### R15 and R15 SC



Bow Storage Compartments



Pre-wired for 12V Trolling Motor



Full Windshield\*  
\*On R15



## **Sit up and take charge.**

### **R Series Tiller Models**

For those who love to keep things simple and hands-on, a tiller model is your go-to fishing buddy. With no console in the way, you'll have more space to move around and cast freely. Plus, the tiller steering gives you that direct, responsive control—perfect for navigating tight spots or sneaking up on your favorite fishing hole. Just make sure everyone onboard keeps a good balance while you're reeling in the big one!

---

#### **Interested in a Tiller model? See the:**

ProSport LS page 20

Widebody page 22

Ultralite page 22



## **Sit back with one hand on the wheel.**

### **R Series Console Models**

Want more comfort and some extra features while you fish? Console models give you a steering wheel, added protection from wind and water, and room for more gadgets. You've got a clear line of sight for cruising the lake and plenty of storage for all your gear. It's ideal for anglers who like a little more structure on their boat while keeping safety and comfort a priority.

---

### **Interested in a Console model? See the:**

R15 page 16

R15 SC page 16

ProSport SC page 18





## Built for the Catch, Loved for the Memories.

Designed to make every fishing trip effortless, the R-Series delivers smart features where they matter most. Track your next big catch with the PiranhaMax 4 Fish Finder, keep your gear secure in the lockable rod box, and enjoy easy access with deluxe rod holders. Plus, a spacious livewell helps you stay ready for action. Thoughtful details, built for anglers—and the memories you'll make along the way. *Features vary by model.*



Fish Finder



Deluxe Rod Holder\*

\*Shown on the R15, varies per model



Spacious livewell\*

\*Shown on the R15, varies per model

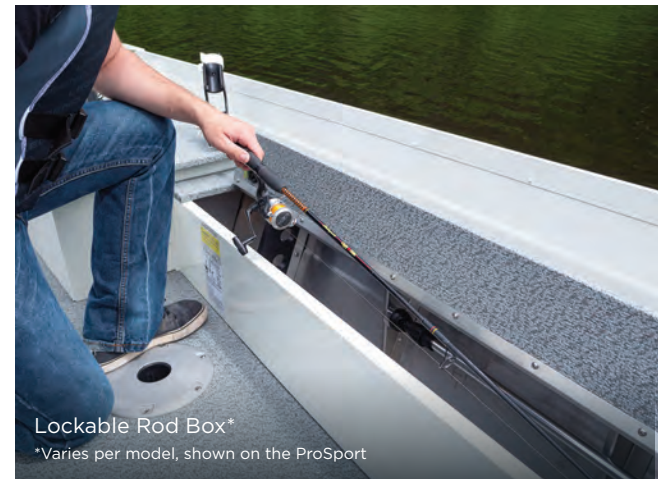

Lockable Rod Box\*

\*Varies per model, shown on the ProSport

---

## Messy catches meet their match.

Spacious Casting Deck | EZ Clean Dura-Deck Flooring

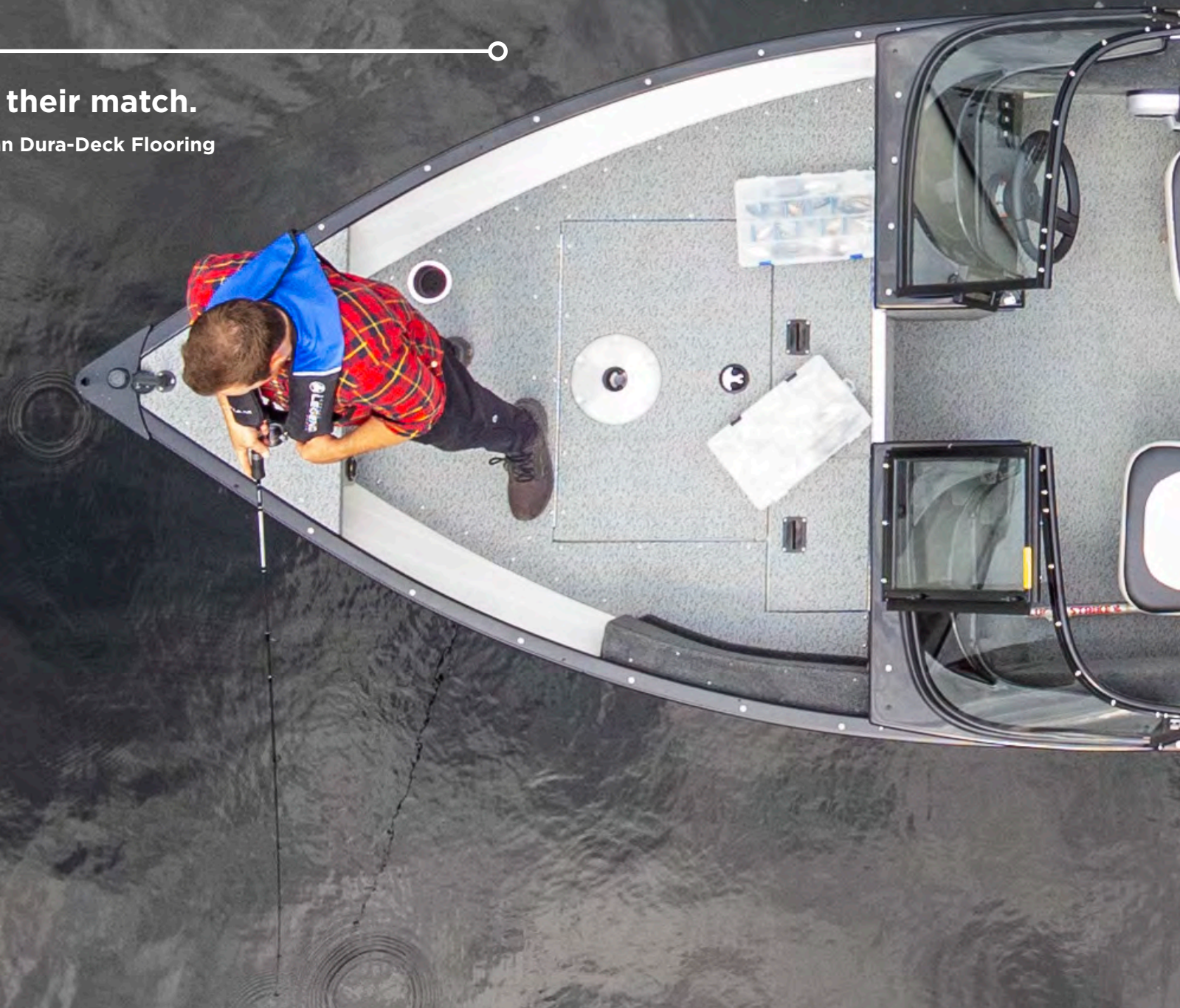



**Your seats, your way—fish where it feels right.**

4-on-the-floor Seat Base Configuration | 360° Swivel Fishing Seats



## **Extend your season.**

**Being Canadian, we understand the harsh reality of the Canadian climate.**

Included on the R15, the Full Stand-Up All-Weather Top protects your interior from the elements so that you can enjoy your boat longer, be more comfortable, warmer, and dryer regardless of what Mother Nature throws at you.



## Full Stand-Up All-Weather Top Features

### Front Aerodynamically Matched to the Windshield

Reduces wind resistance at high speeds on the water, which increases fuel efficiency and allows for full throttle performance with the top up.

### Rear Angled Support Bar

Much stronger than a strap, it adds greatly to the overall strength of the top and allows for the top to be stored in an arch out of the way.

### All Snaps Are Installed Through Thick Legend ProTech Material

Our strong material provides a solid fastening point as opposed to plastic, which snaps could tear through easily.

### Legend ProTech All-Synthetic Tear and Mildew-Resistant Material Backed by a 5 Year Warranty

Guaranteed not to rot, shrink or fade for five years and will resist tearing, even if punctured.



### Extra-Wide Double-Zippered Walk-Through with Window

The walk-through window opens fully to allow for easy passage and allows visibility even when closed.

### Double Stitching

All main zippers are double-stitched to provide lasting quality in the areas that receive the most stress.

### Weather-Resistant Design

Helps to reduce wind and water from entering the boat, keeping you warm and dry.

### Three Bar 7/8" Tubular Frame

Our tubing is thicker and therefore stronger than industry standards. A third center bar keeps the top in an arched formation preventing sag at any speed on the water.



Full tops are not for winter storage or highway travel.



**Strong. Flexible.  
Light-weight. Sustainable.**

### **Legend's H34 PerfectFlex aluminum**

has the perfect balance of strength and flexibility. Although H36 is harder, it is also more brittle. Its strength is reduced by over 80% when stressed during manufacturing or when flexed on the water. In fact, when stressed, H34 PerfectFlex is tested to be more than 2.5 times stronger than H36, making it the ultimate hardness for .100 gauge aluminum boat manufacturing.



### Full-Length Molded Splash Rail

Deflects water away from the boat interior, providing a dry, comfortable ride. Fishing lines are able to slide along the hull edge smoothly where this rail is riveted on.

### Full-Length Deep-V Hull with Squared Chines

Provides a smooth and comfortable ride while keeping the hull stable so you can move around without it feeling tippy.

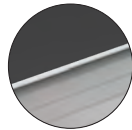

#### Extra-Wide EZ-Grip Gunnel

Makes holding the boat while getting in or out very easy and increases the overall strength of the hull.

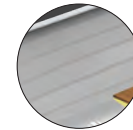

#### Lap-Stracked Side Walls

Full-length ridges pressed into the sidewall reduce flex and make for a stronger and sturdier boat.

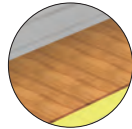

#### Thick Lifetime Decking

With 7 layers, each individually treated, we can offer a Lifetime Warranty against rotting or warping.

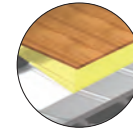

#### Injected and Level Foam Floatation

Provides a stronger, quieter and safer boat. If filled with water, the boat will not flip or sink, even when loaded to capacity.



### 3 External Keels

Provide stability, solid cornering and car-bumper-like protection from underwater obstacles.

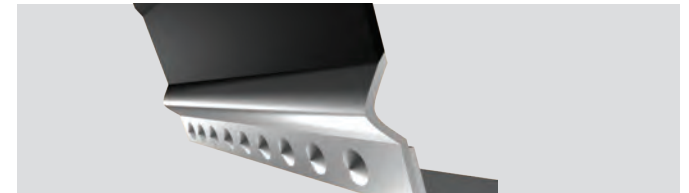

### Side-Facing Rivet Line with Lifetime Warranty

Reduces exposure to side seam stress in comparison to a bottom-facing rivet line.



### Reinforcing Bow Ribs Attached to Transverse Rib

Are reinforced with .100 gauge aluminum that eliminates a common weak area found in the front of most boats.

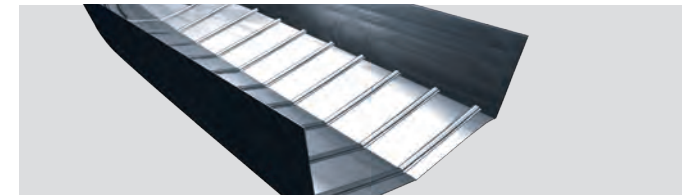

### Internal Lateral Support Ribs Spaced 9" Apart

Gives you more ribs closer together creating greater support and strength.

**ALL-IN PRICE**  
NO EXTRA FEES

## R-SERIES | R15, R15 SC

WE'VE GOT YOU COVERED

**.100 Gauge** Perfect-Flex Aluminum  
**Riveted-Series** Aluminum Hull  
**Lifetime** Seam Warranty  
**+ 6 Year** WOWarranty

### SPECIFICATIONS

	R15	R15 SC
Length	15'1"	15'1"
Beam	76"	76"
Hull Depth	31"	31"
Inside Depth	25"	25"
Bottom Width	64"	64"
Aluminum Thickness	0.100	0.100
Maximum Horsepower	50	50
Maximum Capacity(lbs)	1144	1000
Hull Weight (lbs)	600	570
Towing Weight (lbs)	1450	1420
Package Length	17'1"	17'1"
Package Width	76"	76"
Gas Tank	Portable	Portable



### Surprisingly Included Equipment

R15:	Value:
Full Stand-Up All-Weather Top	\$2,399
Space-Saving Trailer Swing Tongue	\$499
Driver's Seat Slider	\$299
Humminbird PiranhaMAX 4" Fish/Depth Finder	\$299
Big Wheel Backsaver Jack and Dolly	\$119
2 Deluxe Rod Holders	\$79
Legend Quick Latch Tie Downs	\$59

**R15 Value: \$4,052**

**R15 SC:**  
Includes all of the above, plus Removable Tinted Windscreen  
and excluding the Full Stand-Up All-Weather Top

**R15 SC Value: \$2,352**





## R15

**\$57** Per Week | **\$27,999\***

With Mercury 25 ELPT 4S and Glide-On Trailer



Build me!

### Choose Your Power

Fish/Cruise  Tube  Ski

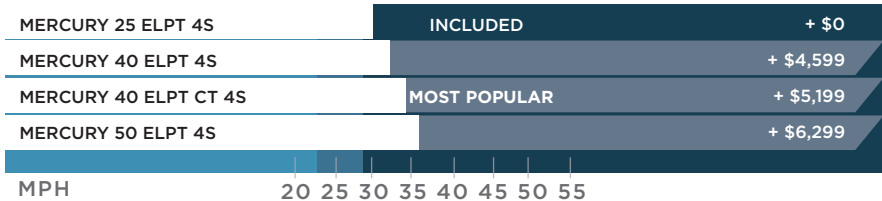

## R15 SC

**\$52** Per Week | **\$25,499\***

With Mercury 25 ELPT 4S and Glide-On Trailer



Build me!

### Choose Your Power

Fish/Cruise  Tube  Ski

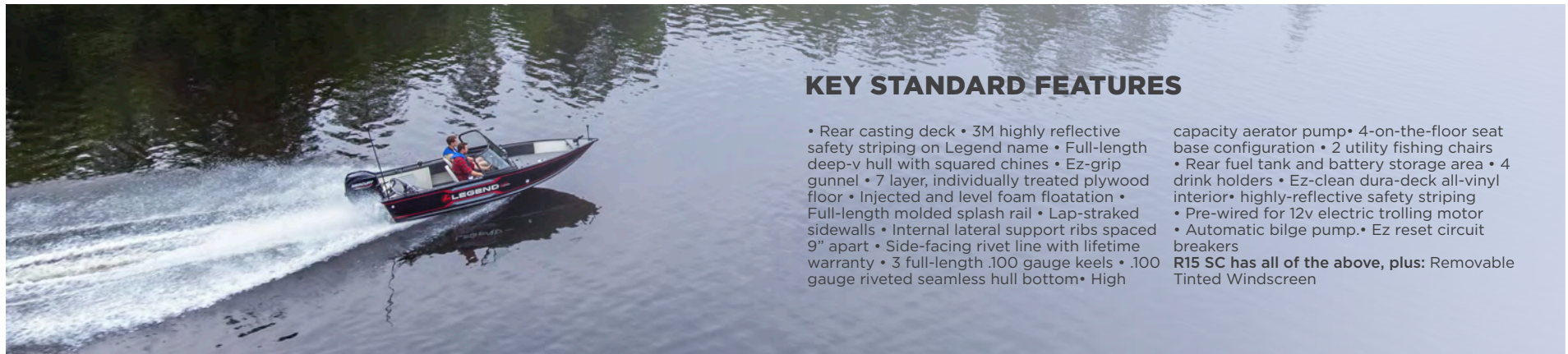
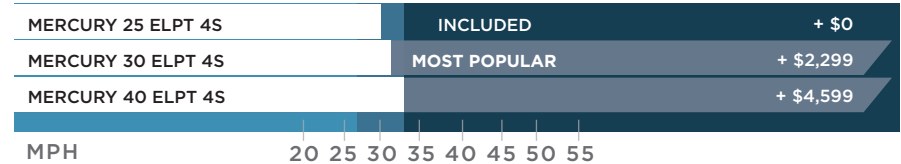

## KEY STANDARD FEATURES

- Rear casting deck • 3M highly reflective safety striping on Legend name • Full-length deep-v hull with squared chines • Ez-grip gunnel • 7 layer, individually treated plywood floor • Injected and level foam flotation • Full-length molded splash rail • Lap-straked sidewalls • Internal lateral support ribs spaced 9" apart • Side-facing rivet line with lifetime warranty • 3 full-length .100 gauge keels • .100 gauge riveted seamless hull bottom • High capacity aerator pump • 4-on-the-floor seat base configuration • 2 utility fishing chairs • Rear fuel tank and battery storage area • 4 drink holders • Ez-clean dura-deck all-vinyl interior • highly-reflective safety striping • Pre-wired for 12v electric trolling motor • Automatic bilge pump • Ez reset circuit breakers
- R15 SC has all of the above, plus:** Removable Tinted Windscreen

**ALL-IN PRICE**  
NO EXTRA FEES

## R-SERIES | PROSPORT SC

WE'VE GOT YOU COVERED

<b>.100 Gauge</b> Perfect-Flex Aluminum	<b>Riveted-Series</b> Aluminum Hull	<b>Lifetime</b> Seam Warranty	<b>+ 6 Year</b> Warranty
--	--	----------------------------------	-----------------------------

### SPECIFICATIONS

16 SC

 Length	16'2"
 Beam	68"
 Hull Depth	29"
 Inside Depth	20"
 Bottom Width	56"
 Aluminum Thickness	0.100
 Maximum Horsepower	40
 Maximum Capacity(lbs)	1201
 Hull Weight (lbs)	600
 Towing Weight (lbs)	1390
 Package Length	18'1"
 Package Width	70"
 Gas Tank	Portable

### Surprisingly Included Equipment

16 ProSport SC:	Value:
Removable Tinted Windscreen	\$699
Space-Saving Trailer Swing Tongue	\$499
HUMMINBIRD PIRANHAMAX 4" Fish/Depth Finder	\$299
EZ-Load Trailer Guides	\$299
Big Wheel Backsaver Jack and Dolly	\$119
2 Deluxe Rod Holders	\$79
Legend Quick Latch Tie Downs	\$59

**16 ProSport SC: \$2,053**





## 16 PROSPORT SC

**\$49** Per Week | **\$23,999\***

With Mercury 25 ELPT 4S and Glide-On Trailer



Build me!

### Choose Your Power

Fish/Cruise 
  Tube 
  Ski

MERCURY 25 ELPT 4S	INCLUDED	+ \$0
MERCURY 30 ELPT 4S	MOST POPULAR	+ \$2,299
MERCURY 40 ELPT 4S		+ \$4,599

MPH 20 25 30 35 40 45 50 55

### KEY STANDARD FEATURES

- 3M highly reflective safety striping
- High-gloss oven-cured urethane exterior paint
- Treated 7-ply marine-grade plywood floor and decks
- Level foam floatation
- Ez-grip gunnel
- Stainless steel transom eyes or lift handles
- Stainless steel bow eye or lift handle
- Aluminum bow with integrated grab and mooring handles
- Heavy-duty transom knee brace
- Full-length molded splash rails
- 3 full-length .100 gauge keels
- .100 gauge full-width bottom ribs
- Multiple .100 gauge bow ribs
- 5" deep-v hull with hard

- chines
- .100 gauge one-piece aluminum seamless hull bottom
- 45 L livewell
- High-capacity aerator pump
- Threaded sure-lock standpipe
- Ez-clean dura-deck all-vinyl interior
- 2 drink holders
- Rear fuel tank and battery storage area
- Bow deck for easy electric motor installation
- Automatic bilge pump with float switch
- Navigational lights
- Pre-wiring for a 12V electric trolling motor
- 2 utility fishing chairs
- 7' port side lockable rod box
- Large bow casting deck with oversized storage compartment



**ALL-IN PRICE**  
NO EXTRA FEES

## R-SERIES | PROSPORT LS

WE'VE GOT YOU COVERED

<b>.100 Gauge</b> Perfect-Flex Aluminum	<b>Riveted-Series</b> Aluminum Hull	<b>Lifetime</b> Seam Warranty	<b>+ 6 Year</b> WOWranty
--	--	----------------------------------	-----------------------------

SPECIFICATIONS	14 LS	16 LS
Length	14'3"	16'2"
Beam	68"	68"
Hull Depth	29"	29"
Inside Depth	20"	20"
Bottom Width	56"	56"
Aluminum Thickness	0.100	0.100
Maximum Horsepower	30	30
Maximum Capacity(lbs)	920	1220
Hull Weight (lbs)	460	508
Towing Weight (lbs)	1250	1300
Package Length	17'1"	18'1"
Package Width	70"	70"
Gas Tank	Portable	Portable

### Surprisingly Included Equipment

14, 16 ProSport LS:	Value:
Space-Saving Trailer Swing Tongue	\$499
HUMMINBIRD PIRANHAMAX 4" Fish/Depth Finder	\$299
EZ-Load Trailer Guides	\$299
Big Wheel Backsaver Jack and Dolly	\$119
2 Deluxe Rod Holders	\$79
Legend Quick Latch Tie Downs	\$59

**14, 16 ProSport LS Value: \$1,354**







## 14 PROSPORT LS

**\$48** Per Week | **\$18,999\***

With Mercury 20 ELH EFI 4S and Glide-On Trailer



Build me!

### Choose Your Power

MERCURY 20 ELH EFI 4S		+ \$0
MERCURY 20 ELHPT EFI 4S	<b>MOST POPULAR</b>	+ \$699
MERCURY 25 ELHPT 4S		+ \$1,499
MERCURY 30 ELHPT 4S		+ \$3,399

14 ProSport LS Boat Only Price ..... \$11,999\*

## KEY STANDARD FEATURES

3M highly reflective safety striping•High-gloss oven-cured urethane exterior paint•Treated 7-ply marine-grade plywood floor and decks•Level foam flotation•Ez-grip gunnel•Stainless steel transom eyes or lift handles•Stainless steel bow eye or lift handle  
•Aluminum bow with integrated grab and mooring handles•Heavy-duty transom knee brace•Full-length molded splash rails•3 full-length .100 gauge keels•.100 gauge full-width bottom ribs•Multiple .100 gauge bow ribs•5° deep-v hull with hard chines•

.100 gauge one-piece aluminum seamless hull bottom  
•45 L livewell•High-capacity aerator pump•Threaded sure-lock standpipe•Ez-clean dura-deck all-vinyl interior•2 drink holders•Rear fuel tank and battery storage area•Bow deck for easy electric motor installation•Automatic bilge pump with float switch•Navigational lights•Pre-wiring for a 12V electric trolling motor•Split vinyl-covered rear seats  
•2 removable fishing chairs•6.5' port side lockable rod box•Large front casting deck with oversized storage



## 16 PROSPORT LS

**\$56** Per Week | **\$21,999\***

With Mercury 20 ELH EFI 4S and Glide-On Trailer



Build me!

### Choose Your Power

MERCURY 20 ELH EFI 4S		+ \$0
MERCURY 20 ELHPT EFI 4S		+ \$699
MERCURY 25 ELHPT 4S	<b>MOST POPULAR</b>	+ \$1,499
MERCURY 30 ELHPT 4S		+ \$3,399

16 ProSport LS Boat Only Price ..... \$14,699\*



**ALL-IN PRICE**  
NO EXTRA FEES













# R-SERIES | WIDEBODY, ULTRALITE

WE'VE GOT YOU COVERED

 <b>.100 Gauge</b> Perfect-Flex Aluminum On Widebody models	 <b>Riveted-Series</b> Aluminum Hull	 <b>Lifetime</b> Seam Warranty	 <b>+ 6 Year</b> WOWranty
--	--	--	---



## SPECIFICATIONS

	14/16 WB	12/14 U		14/16 WB	12/14 U
 Length	14'3"/16'2"	11'9"/13'10"	 Maximum Capacity(lbs)	1047/1100	627/700
 Beam	68"/68"	56"/59"	 Hull Weight (lbs)	245/353	112/130
 Hull Depth	29"/29"	20"/20"	 Towing Weight (lbs)	857/1040	-
 Inside Depth	20"/20"	20"/20"	 Package Length	17'1"/18'4"	-
 Bottom Width	56"/56"	-	 Package Width	70"/70"	-
 Aluminum Thickness	0.100/0.100	0.050/0.050	 Gas Tank	Portable	Portable
 Maximum Horsepower	30/30	10/15			





Shown with optional motor and trailer.

### 14 WIDEBODY BOAT ONLY

**\$38** Per Week | **\$6,999\***



Build me!

### 16 WIDEBODY BOAT ONLY

**\$30** Per Week | **\$9,499\***



Build me!

#### Choose Your Power

**MP** = 14 MOST POPULAR **MP** = 16 MOST POPULAR

MERCURY 9.9 MLH EFI 4S	+ \$3,369
MERCURY 15 MLH EFI 4S	<b>MP</b> + \$3,649
MERCURY 20 ELH 4S	<b>MP</b> + \$4,429
MERCURY 25 ELHPT 4S	+ \$5,689
MERCURY AVATOR 7.5 ELH	+ \$5,049

\*Electric start models will require an optional Marine starting battery. Installation and setup of motors are extra. See your dealer for details.

#### Choose Your Trailer

2025 SHORELAND'R DUB10TM	+ \$1,949
2025 SHORELAND'R DUB10TM GALV	+ \$2,149



### 12 ULTRALITE BOAT ONLY

**\$23** Per Week | **\$4,999\***



Build me!

### 14 ULTRALITE BOAT ONLY

**\$25** Per Week | **\$5,699\***



Build me!

#### Choose Your Power

**MP** = 12 MOST POPULAR **MP** = 14 MOST POPULAR

MERCURY 2.5 MH 4S	+ \$1,189
MERCURY 3.5 MH 4S	+ \$1,419
MERCURY 4 MH 4S	<b>MP</b> + \$1,699
MERCURY 6 MH 4S	<b>MP</b> + \$1,949
MERCURY 9.9 MH EFI 4S	+ \$3,319
MERCURY AVATOR 7.5 ESH	+ \$4,999

#### Choose Your Trailer

2025 SHORELAND'R DUB10TM	+ \$1,949
2025 SHORELAND'R DUB10TM GALV	+ \$2,149



## R15

### LIVEWELLS

High-capacity aerator pump  
57 L Bow livewell

Threaded sure-lock stand pipe with overflow protection

### SEATING

4-on-the-floor seat base configuration  
2 utility fishing chairs

### DECKS AND STORAGE

Ez-clean dura-deck all-vinyl interior  
Large bow casting deck with oversized storage compartment  
Rear casting deck  
Rear fuel tank and battery storage area  
4 drink holders  
-Bow deck for easy electric motor installation  
6'8" port side lockable rod box

### SAFETY

Highly-reflective safety striping  
Automatic bilge pump with float switch  
Navigational lights

### ADDITIONAL

Pre-wired for 12v electric trolling motor

### CONSOLE

Ez reset circuit breakers

### CONSTRUCTION

3M highly reflective safety striping on Legend name  
Full-length deep-v hull with squared chines  
EZ-grip gunnel  
7-layer, individually treated plywood floor  
Injected and level foam floatation  
Full-length molded splash rail  
Lap-straked sidewalls  
Internal lateral support ribs spaced 9" apart  
Side-facing rivet line with lifetime warranty  
3 full-length .100 gauge keels  
.100 gauge riveted seamless hull bottom  
Stainless steel bow eye or lift handle  
Aluminum bow with integrated grab and mooring handles  
Heavy-duty transom knee brace



## R15 SC

### LIVEWELLS

High-capacity aerator pump  
57 L Bow livewell

Threaded sure-lock stand pipe with overflow protection

### SEATING

4-on-the-floor seat base configuration  
2 utility fishing chairs

### DECKS AND STORAGE

Ez-clean dura-deck all-vinyl interior  
Large bow casting deck with oversized storage compartment  
Rear casting deck  
Rear fuel tank and battery storage area  
4 drink holders  
Bow deck for easy electric motor installation  
6'8" port side lockable rod box

### SAFETY

Highly-reflective safety striping  
Automatic bilge pump with float switch  
Navigational lights

### ADDITIONAL

Pre-wired for 12v electric trolling motor

### CONSOLE

Ez reset circuit breakers  
Removable Tinted Windscreen

### CONSTRUCTION

3M highly reflective safety striping on Legend name  
Full-length deep-v hull with squared chines  
EZ-grip gunnel  
7-layer, individually treated plywood floor  
Injected and level foam floatation  
Full-length molded splash rail  
Lap-straked sidewalls  
Internal lateral support ribs spaced 9" apart  
Side-facing rivet line with lifetime warranty  
3 full-length .100 gauge keels  
.100 gauge riveted seamless hull bottom  
Stainless steel bow eye or lift handle  
Aluminum bow with integrated grab and mooring handles  
Heavy-duty transom knee brace



## 16 PROSPORT SC

### LIVEWELLS

High-capacity aerator pump  
45 L livewell

Threaded sure-lock stand pipe with overflow protection

### SEATING

4-on-the-floor seat base configuration  
2 utility fishing chairs

### DECKS AND STORAGE

Ez-clean dura-deck all-vinyl interior  
Large bow casting deck with oversized storage compartment  
Rear casting deck  
Rear fuel tank and battery storage area  
2 drink holders  
Bow deck for easy electric motor installation  
7' port side lockable rod box

### SAFETY

Highly-reflective safety striping  
Automatic bilge pump with float switch  
Navigational lights

### ADDITIONAL

Pre-wired for 12v electric trolling motor

### CONSOLE

Ez reset circuit breakers  
Removable Tinted Windscreen

### CONSTRUCTION

3M highly reflective safety striping on Legend name  
Full-length deep-v hull  
EZ-grip gunnel  
7-layer, individually treated plywood floor  
Injected and level foam floatation  
Full-length molded splash rails  
Lap-straked sidewalls  
.100 gauge full-width bottom ribs  
-  
3 full-length .100 gauge keels  
.100 gauge riveted seamless hull bottom  
Stainless steel transom eyes or lift handles  
Stainless steel bow eye or lift handle  
Aluminum bow with integrated grab and mooring handles  
Heavy-duty transom knee brace



Shown with trailer package.

## 14, 16 PROSPORT LS

### LIVEWELLS

High-capacity aerator pump  
45 L livewell

Threaded sure-lock stand pipe with overflow protection

### SEATING

Split vinyl-covered rear seats  
2 removable fishing chairs

### DECKS AND STORAGE

Ez-clean dura-deck all-vinyl interior  
Large bow casting deck with oversized storage  
Rear fuel tank and battery storage area  
2 drink holders  
Bow deck for easy electric motor installation  
6.5' port side lockable rod box

### SAFETY

Highly-reflective safety striping  
Automatic bilge pump with float switch  
Navigational lights

### ADDITIONAL FEATURES

Pre-wired for 12v electric trolling motor

### CONSTRUCTION

3M highly reflective safety striping on Legend name  
5° deep-v hull with hard chines  
Ez-grip gunnel  
7-layer, individually treated plywood floor  
Level foam floatation  
Full-length molded splash rails  
.100 gauge full-width bottom ribs  
3 full-length .100 gauge keels  
.100 gauge one-piece aluminum seamless hull bottom  
Stainless steel transom eyes or lift handles  
Stainless steel bow eye or lift handle  
Aluminum bow with integrated grab and mooring handles  
Heavy-duty transom knee brace



Shown with optional trailer.

## 14, 16 WIDEBODY

### SEATING

Split vinyl-covered rear seats  
2 full-width benches  
Vinyl-covered front bench

### DECKS AND STORAGE

Drop 'n' go port and starboard rod holders  
Rear fuel tank and battery storage area

### CONSTRUCTION

3M highly reflective safety striping on Legend name  
5° deep-v hull with hard chines  
Ez-grip gunnel  
Level foam floatation  
Full-length molded splash rails  
3 full-length .100 gauge keels  
.100 gauge one-piece aluminum seamless hull bottom  
Stainless steel transom eyes or lift handles  
Stainless steel bow eye or lift handle  
Aluminum bow with integrated grab and mooring handles  
Heavy-duty transom knee brace  
Multiple .100 gauge bow ribs for maximum strength  
High-gloss oven-cured urethane exterior paint  
Slip-resistant and anti-glare non-skid interior paint  
Two oar locks

### 16 WIDEBODY / LIVEWELLS

High-capacity aerator pump  
38 L livewell  
Threaded sure-lock stand pipe with overflow protection



## 12, 14 ULTRALITE

### SEATING

3 full-width high-mounted aluminum benches

### CONSTRUCTION

Riveted hull  
Two oar locks  
Aluminum bow and corner caps with integrated grab handles

# R-Series Must-Haves:

## Bow to Stern Cover

14' \$999 | 15' \$1,199 | 16' SC \$1,199 | 16' LS \$999

Our custom-fit bow to stern mooring cover provides complete protection for your Legend boat. Protect your investment and keep your boat looking new.

(Not for winter storage)



### Quick and Easy Ratchet System

Just slide the cover over top of your boat, tighten up the ratchet and you're done. It's that easy!

\*Installation Extra. See Dealer for details.



### Multi-vent Air Circulation System

Vents humidity to let your boat dry quickly.

## Utility Fishing Chair Kit \$549

Extra comfort for your co-captain.

- Wood-Free
- Invisible Hinges
- Ergonomically Designed For Extreme Comfort
- Larger Seating Surface
- Folds Flat For A Cleaner Surface



# UTILITY SEAT KIT

## Seat Slider \$299

This slider has a gear tooth lock mechanism, locks solidly, disengages easily and rides smoothly on acetal linear bearings.

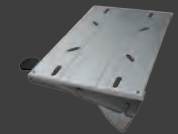

# 35600281

## Pro Seat \$299

Allows for excellent stand-up casting positions. Includes: Pro Seat, auto-locking seat mount and extra-long 25" post.

- COMPACT DESIGN

# PRO SEAT KIT GREY



## Legend Fender Kit \$79

Everything you need to get started including:

- 3 Legend 5"x20" Fenders
- 3 Fender Loops
- 1 Legend Key Float
- 1 Legend Bag

# LEGEND FENDER KIT BLACK



## Upgrade your straps \$99

The TowBetter Auto Retractable Tie Down Includes a retractable ratchet nylon strap, retracts for convenient storage. S-hooks with a vinyl coating protects the aluminum paint finish of the boat. All necessary hardware is included.

# BTDTP3B



## Deluxe Safety Kit \$349

Everything required by Transport Canada for boating on most lakes.

**Total Value \$378** # DELUXE SAFETY KIT

### BUY THE PACKAGE AND SAVE \$29

Package includes:

- 4 Universal Legend Life Jackets
- 50 ft Buoyant Heaving Line
- Fire Extinguisher
- 2 Mooring Lines
- Safety Whistle
- Waterproof Flashlight
- 10 lb Anchor with 50 ft Rope
- Telescopic Paddle
- Bailing Bucket

See the Transport Canada Safe Boating Guide for your safety requirements.



## Motor Support \$159

Protect your boat's transom and motor from trailering stress. This extendable reach motor support is specifically designed for Legend Glide-On trailers.

# 55-1921

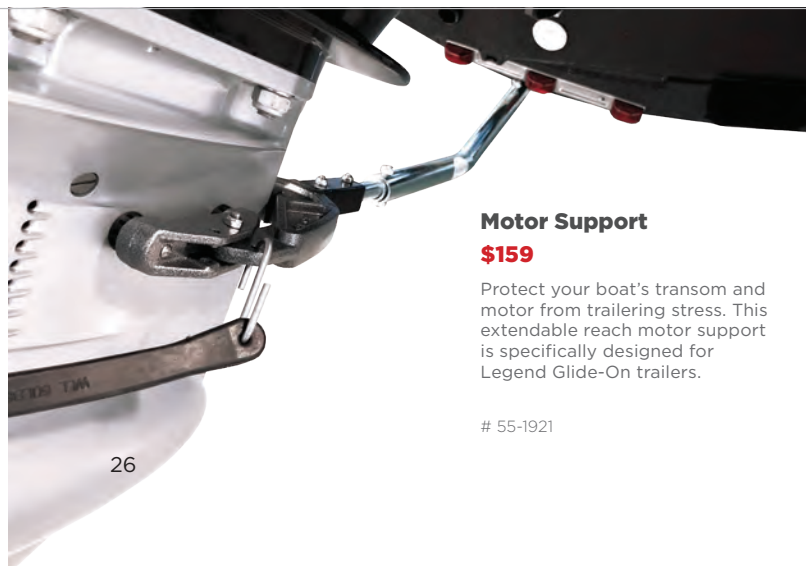



## Fish Tech 55 **\$2,999\***

plus installation\* (Approx 2hrs) #FishTech55Package  
Requires one optional Deep Cycle Battery.

**Get the basics covered. The perfect package for the angler wanting to level-up their time on the water.**



### POWERDRIVE 55/DSC/MR

Reliable. Capable. And fully able to handle anything a day of fishing brings. PowerDrive™ shows up to the launch ramp every day with big-time technology, trusted power and easy operation.

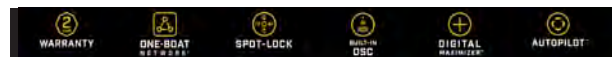

### HELIX 7 CHIRP GPS G4N

Includes Dual Spectrum CHIRP Sonar, AutoChart Live, Internal GPS and Humminbird Basemap built-in. An upgraded high-definition 7" display will give you the best view of the many pre-loaded split screen view options so that you'll never miss a fish.

### RAM MOUNT

Paired with your Helix 7 and installed at the bow, offering precise control of your built-in DSC trolling motor transducer.

### NAVIONICS\*+CANADA

Navionics\*+ mapping offers integrated marine content that details coastal features plus thousands of rivers, bays and lakes around the world.

## See more, catch more. Standalone Upgrades



### POWERDRIVE 45 MR 54" **\$1,399**

Reliable. Capable. And fully able to handle anything a day of fishing brings. PowerDrive™ shows up to the launch ramp every day with big-time technology, trusted power and easy operation.



- 12 Volt, 45 lbs thrust, 54" shaft
- GPS-enabled model shipped with micro remote
- Fully compatible with Humminbird fish finder units
- Phone App Compatible (Free Download)
- Push to Test Battery Meter
- Digital Maximizer
- Power Prop

\*Installation Extra. See Dealer for details.



### Helix 5 CHIRP GPS G3 **\$489** #411660-1

This HELIX 5 CHIRP GPS G3 model features Dual Spectrum CHIRP 2D sonar, internal GPS with Humminbird Basemap and AutoChart Live built-in, with additional compatibility for Humminbird and Navionics premium fishing charts.

\*Installation Extra. See Dealer for details.



### Helix 7 CHIRP GPS G4N **\$1,049** #411630-1

Features MEGA Down Imaging, Dual Spectrum CHIRP Sonar, AutoChart Live, Internal GPS and Humminbird Basemap built-in. An upgraded high-definition 7" display will give you the best view of the many pre-loaded split screen view options so that you'll never miss a fish.

\*Installation Extra. See Dealer for details.



### Universal Ram Mount **\$112** #170-RAM111

\*Installation Extra. See Dealer for details.



**With a rapidly growing Dealer Network, Legend is taking Canada boating!**



## Freight Charges by Zone.

= Headquarters Whitefish, Ontario

Zone	ON, QC	MB, NB, PE, NS	SK	AB	BC	NL
Utility Boat Only	No Fee	\$600	\$650	\$1,100	\$1,250	\$1,400
Boat Package	No Fee	\$1,175	\$1,400	\$2,075	\$2,400	\$3,500

### No Fee Setup and Orientation

All of the components of your boat, motor, and trailer package have been specially chosen for compatibility. The professionals at your authorized Legend Dealership will help you select the proper motor and options for your package. They will then prepare your package to ensure proper and worry-free operation.

### Side console and full windshield models:

The setup includes the following items: control box, shift cables, starting battery, aluminum propeller, outboard installation and setup. Your dealer will prepare your package and give you a full orientation to ensure trouble-free boating from day one.

### ProSport Tiller models in packages:

The setup includes the following items: outboard installation and setup, propeller, fuel tank, starting battery on packages with electric start motor or utility boat models with lights or livewells. Your dealer will prepare your package and give you a full orientation to ensure trouble-free boating from day one. Tiller model boats like the 14/16 WideBody and 12/14 Ultralite, will be subject to installation charges if motors, trailers or other accessories are added. See your dealer for details.

\* Freight charges outside of Zone 1 (Ontario and Quebec), licenses, and taxes are extra on all prices. Delivery is available at an additional cost. Payments are calculated with licenses, bank registration charges, and taxes as your down-payment at 8.99% over 1,040 weeks for amounts \$23,000 and higher, 9.99% over 780 weeks for amounts between \$10,000 and \$22,999, and 9.99% over 364 weeks for amounts less than \$10,000 (at time of printing). All financing is OAC. Payments will vary by province. All Choose your power prices are in addition and only available with the purchase of the specific package they are listed with; they are not stand alone motor prices. Towing weights are approximate and are calculated based on a full tank of fuel and 200 pounds for batteries and gear. Speed tests were done with 2 persons, 50 pounds of gear and proper weight distribution. Actual performance may vary. Prices, rates and specifications are subject to change or error. Pictures may show options. Ask for complete details. All illustrations, photographs and specifications in this catalogue are based on the latest product information. See actual boat for complete accuracy. Legend reserves the right to make changes at any time, without notice, in prices, colours, materials, equipment, specifications and models, and to discontinue models or equipment. For information on accessories, contact your local Legend dealer.

Please refer to your provincial laws regarding trailer brakes and ensure that your boat package and tow vehicle comply with the regulations in the provinces you intend to travel in. Brakes may be required in certain circumstances and can be purchased as an option or your trailer model can be upgraded before delivery if brakes are not available on certain trailers. It is your sole responsibility to ensure you comply with all provincial brake requirements for vehicles and also that you always operate your tow vehicle safely. Legend Boats accepts no responsibility with regards to provincial compliance.

At Legendboats.com, you'll find a fully-priced electronic version of our catalogue as well as additional pictures and special offers. Always distribute passengers and cargo evenly, wear a PFD and follow the rules for safe boating. Visit: [www.tc.gc.ca/boatingsafety](http://www.tc.gc.ca/boatingsafety)



# Choose Your Power.

Ask your Legend dealer to help you select the Mercury outboard that best suits your needs from the motor choices below. Use the chart that corresponds with the standard engine packaged with your boat model. Simply add the amount to the standard package price to have the motor that is perfect for you.

E = Electric Start  
L = Long Shaft  
PT = Power Trim and Tilt  
CT = Command Thrust

## R-Series

FROM A 25 ELPT 4-STROKE TO



+ \$2,299  
30 ELPT 4S



+ \$4,599  
40 ELPT 4S



+ \$5,199  
40 ELPT CT 4S



+ \$6,299  
50 ELPT 4S



# Our mission is to Create Memories.

Whether we are working on a cool new design, adding an innovative feature, or squeezing in that extra bit of value, all we're thinking about is providing you with the ultimate boating experience and creating memories that will last a lifetime.

---

Did you know that the Legend headquarters is in Whitefish, Ontario? We have knowledgeable representatives available to answer your questions and direct you to your nearest Dealer. Conveniently reach out via text or call our toll-free number, +1 833-602-5626 and start on the path to finding your new boat.

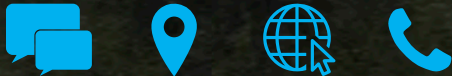

Visit our website, chat  
live or find your dealer:

[legendboats.com](http://legendboats.com)

